

TROP X45

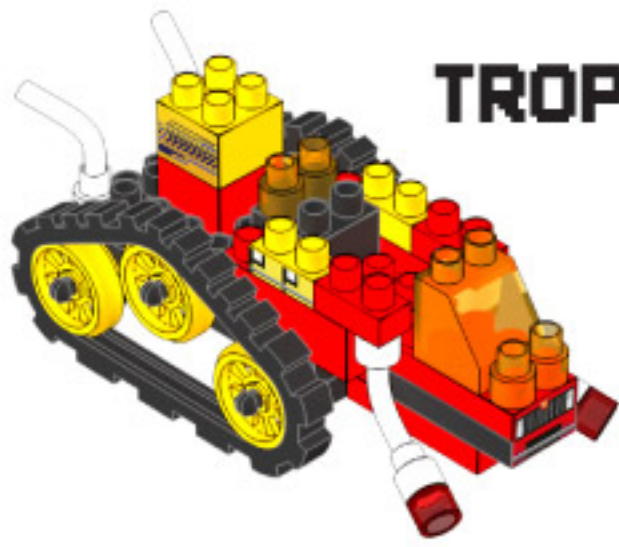

1

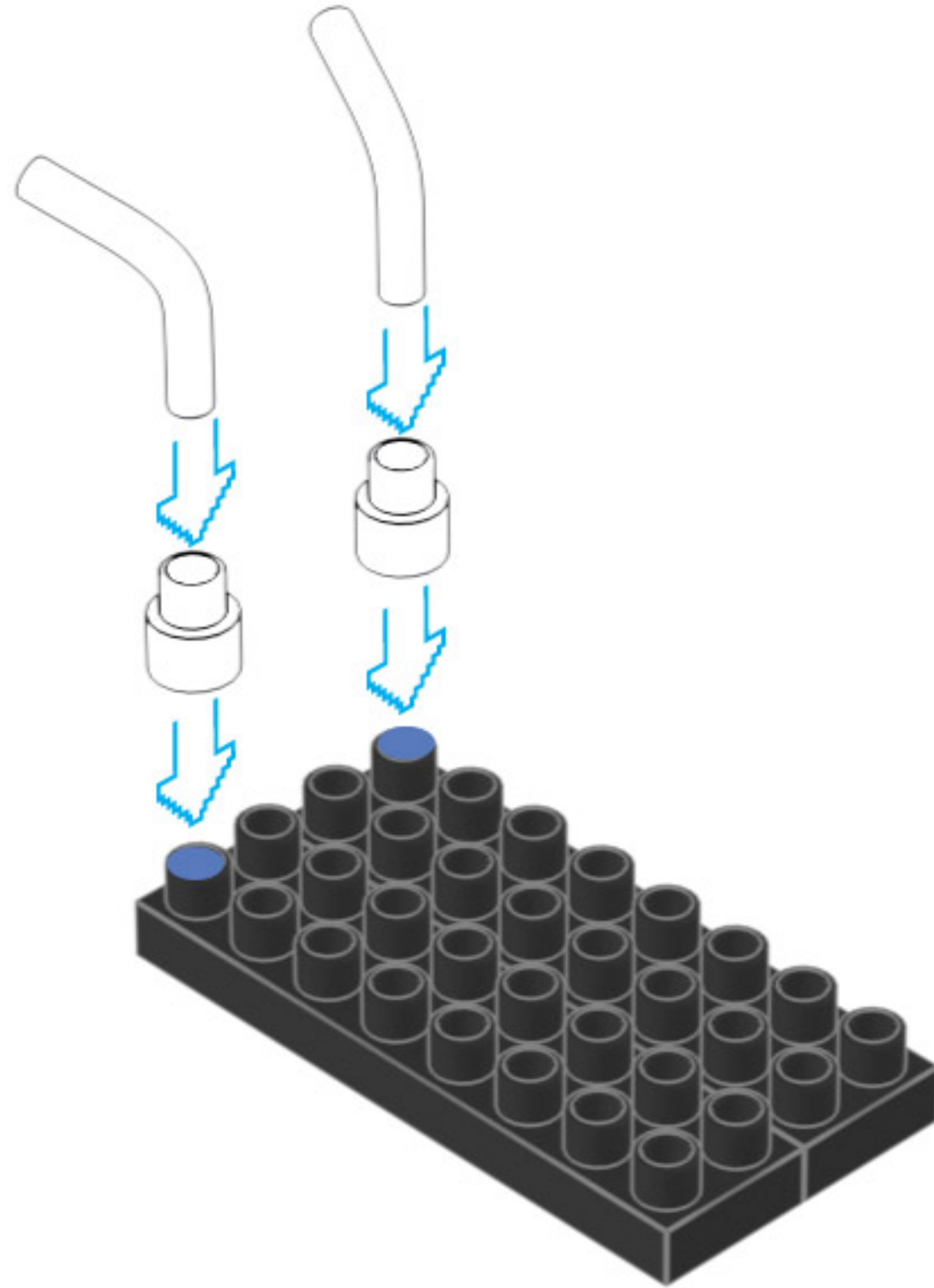

2

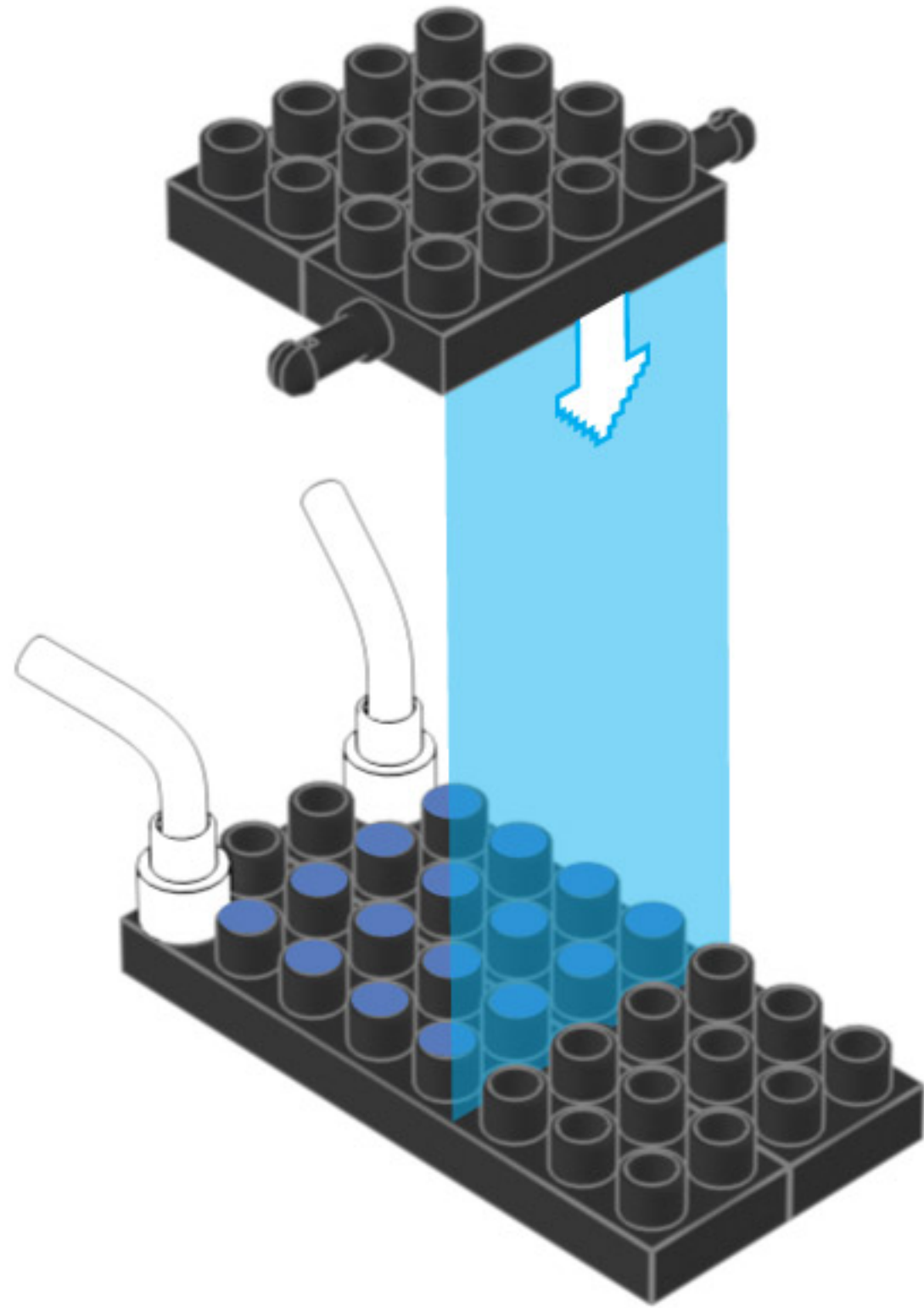
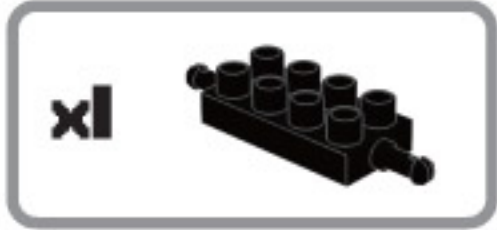
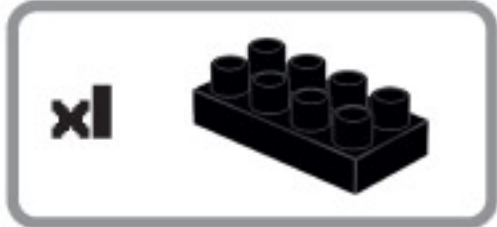

3

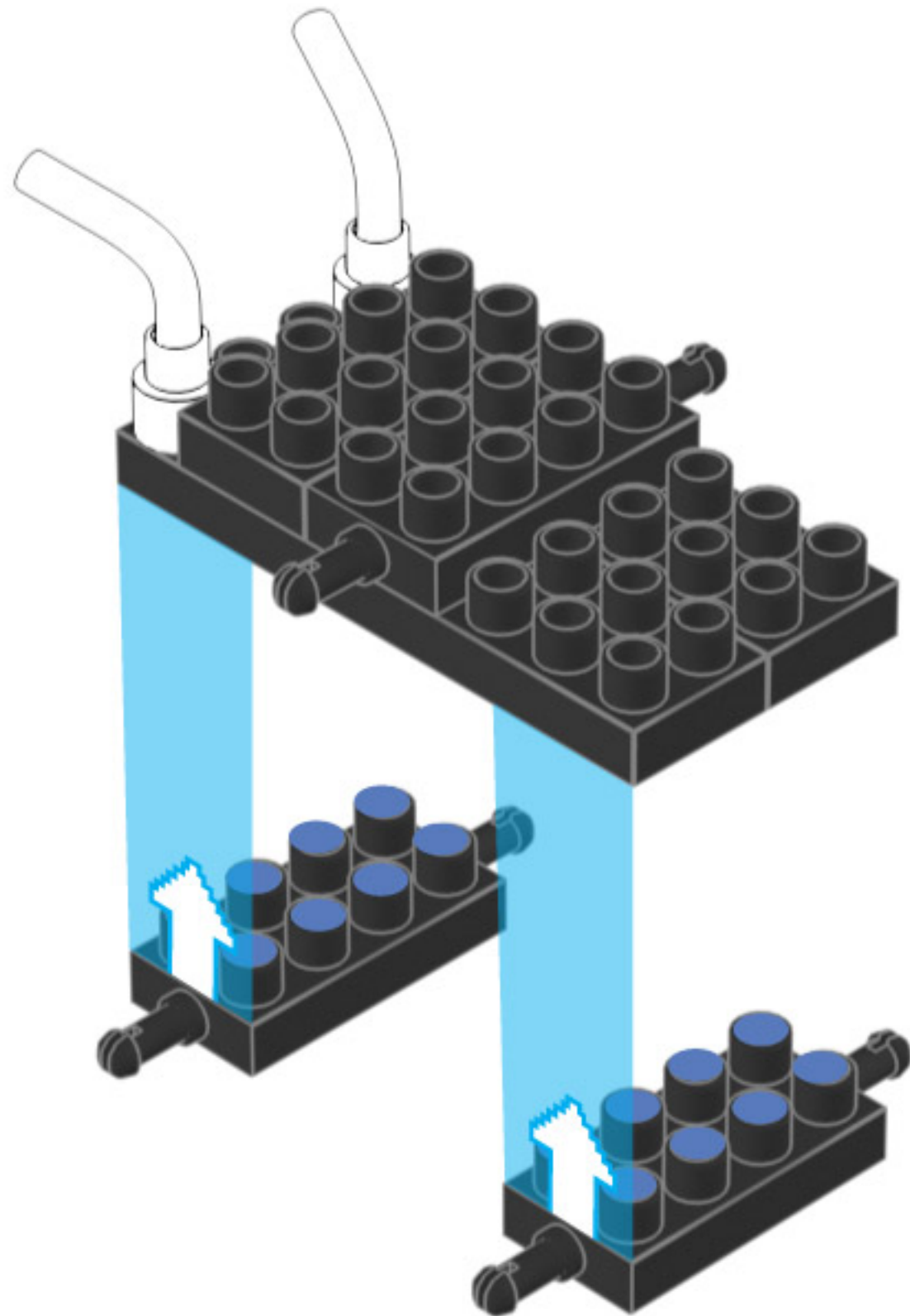
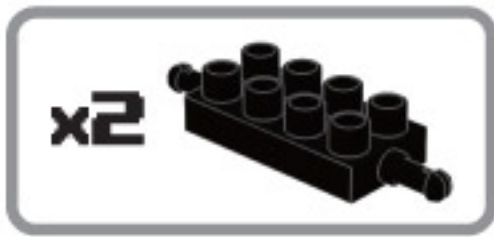

4

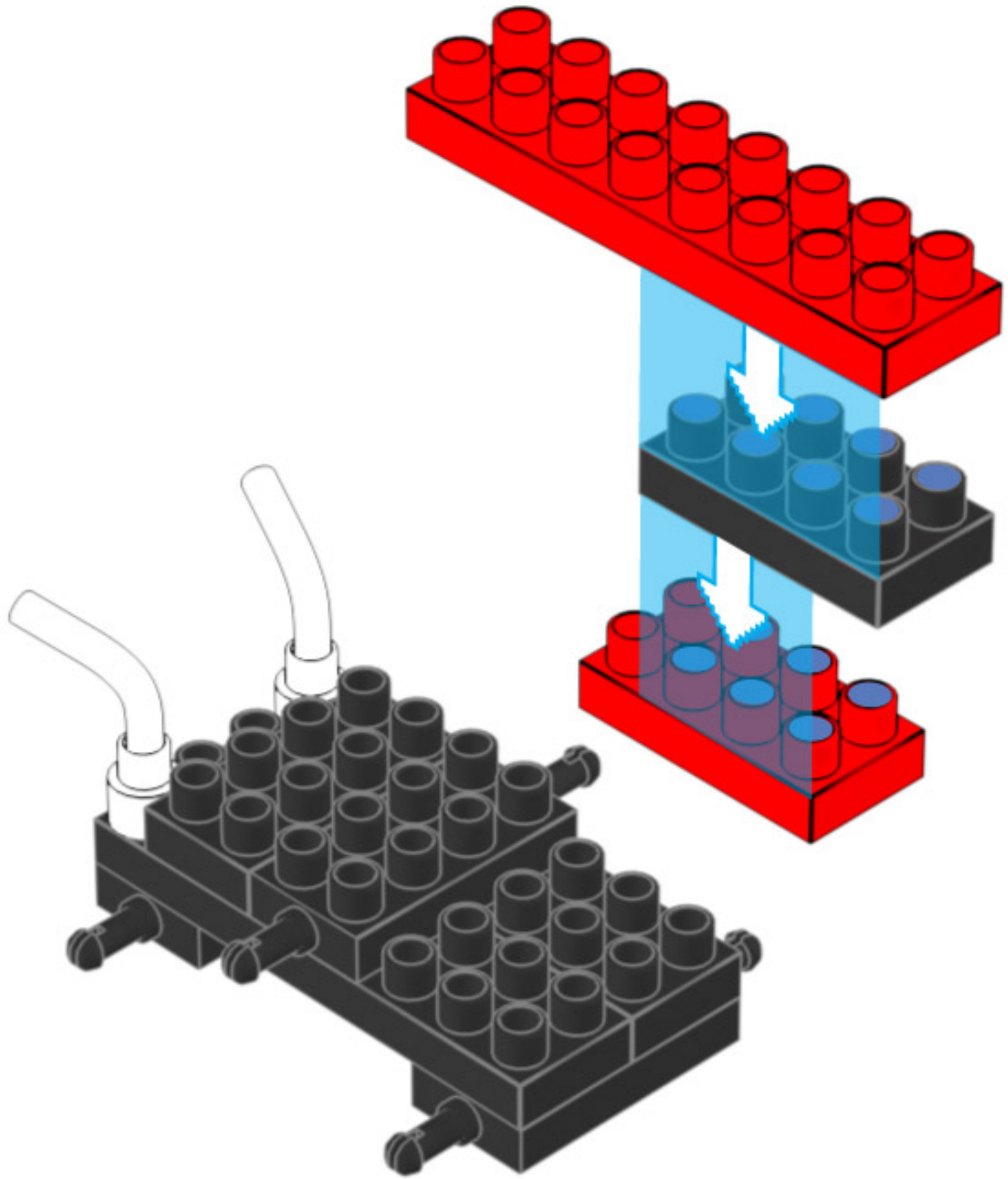
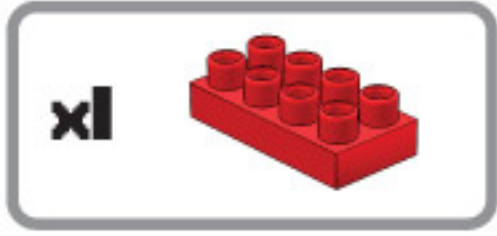
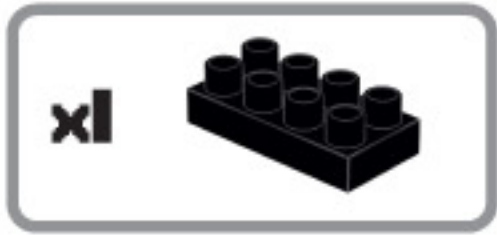
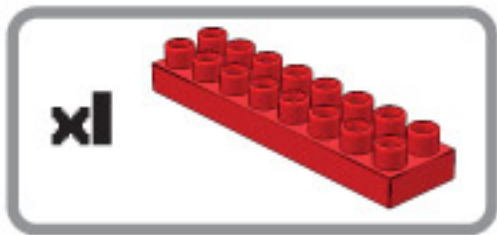

5

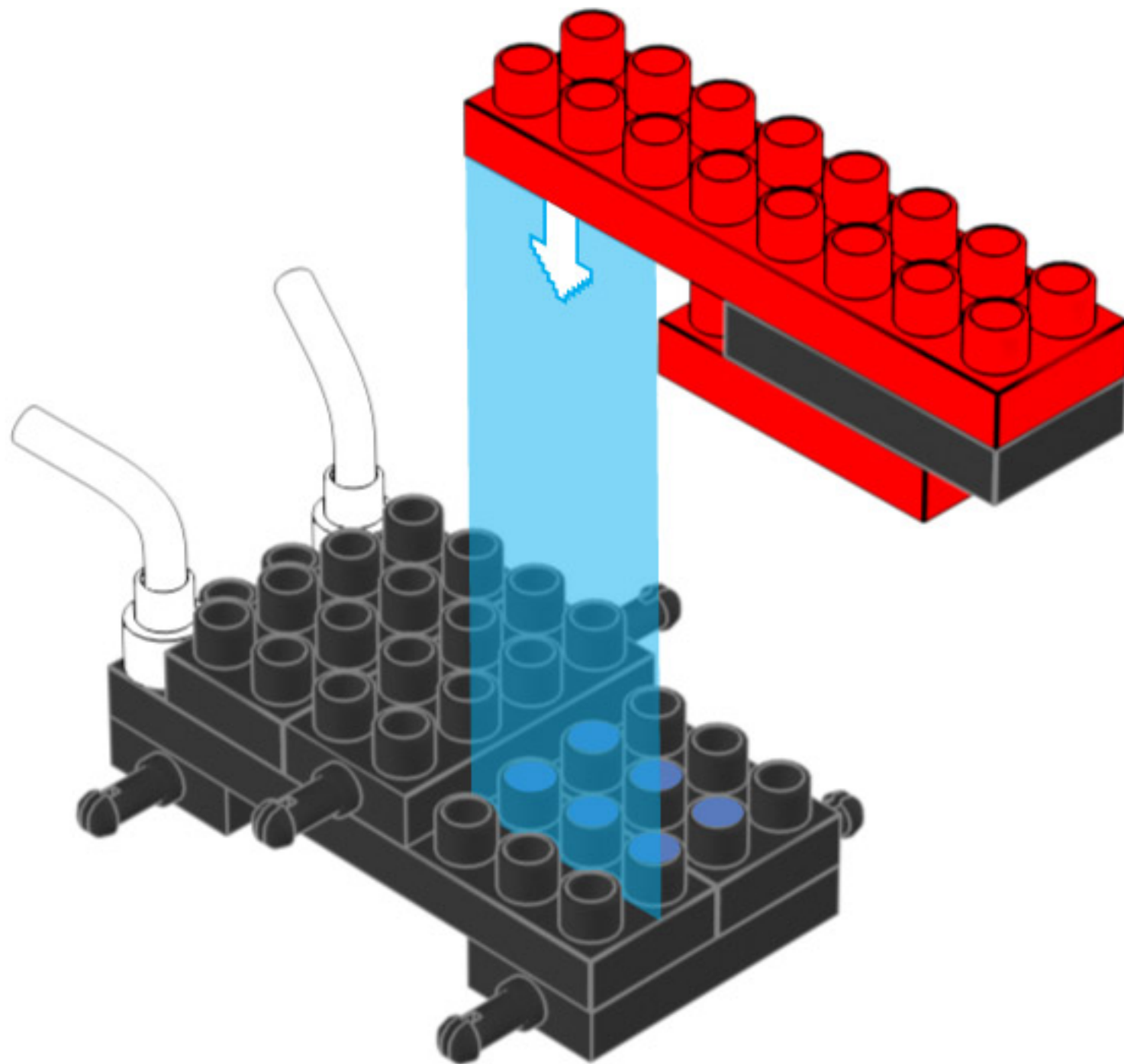

6

x1



x1

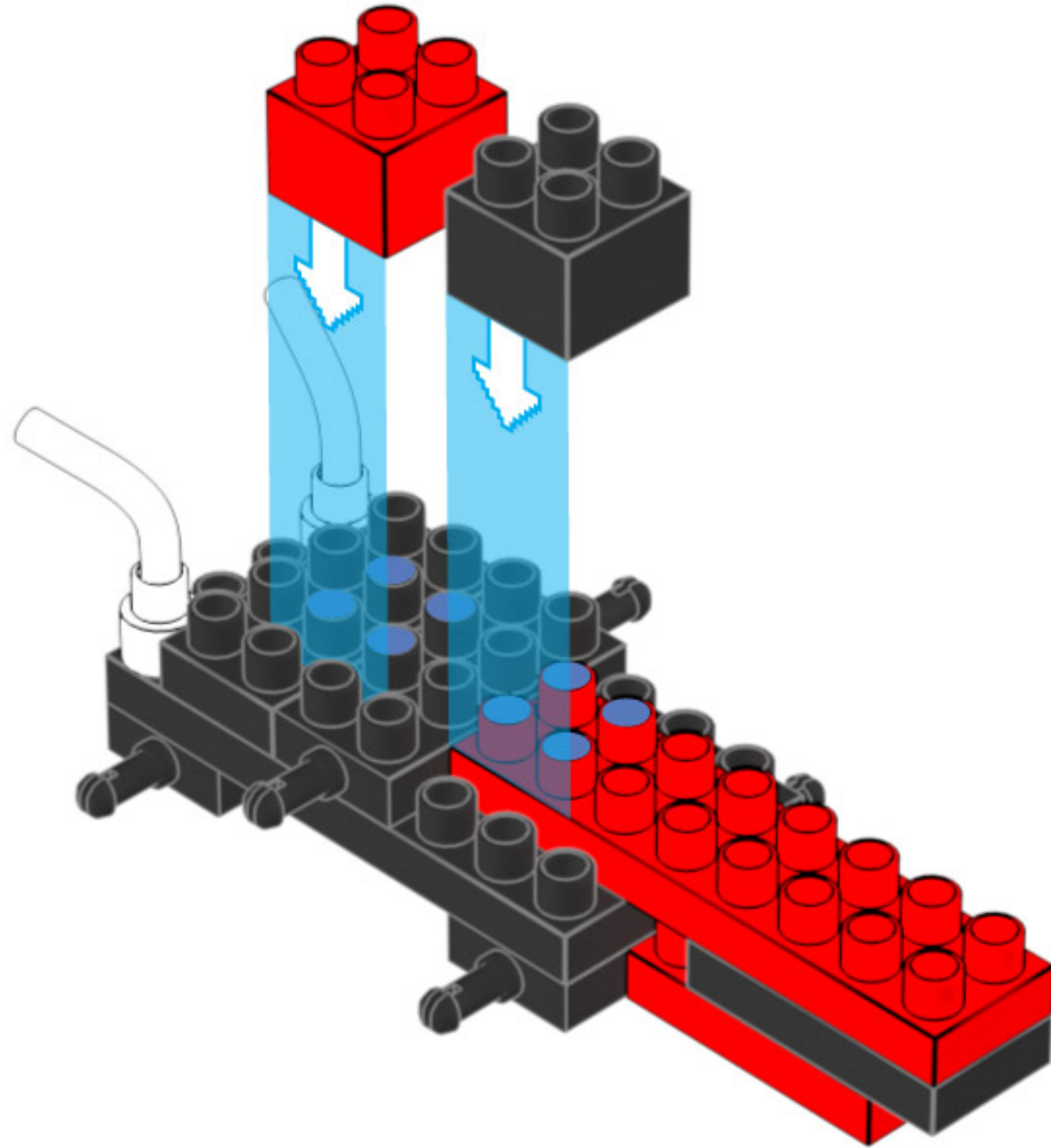

7

x2

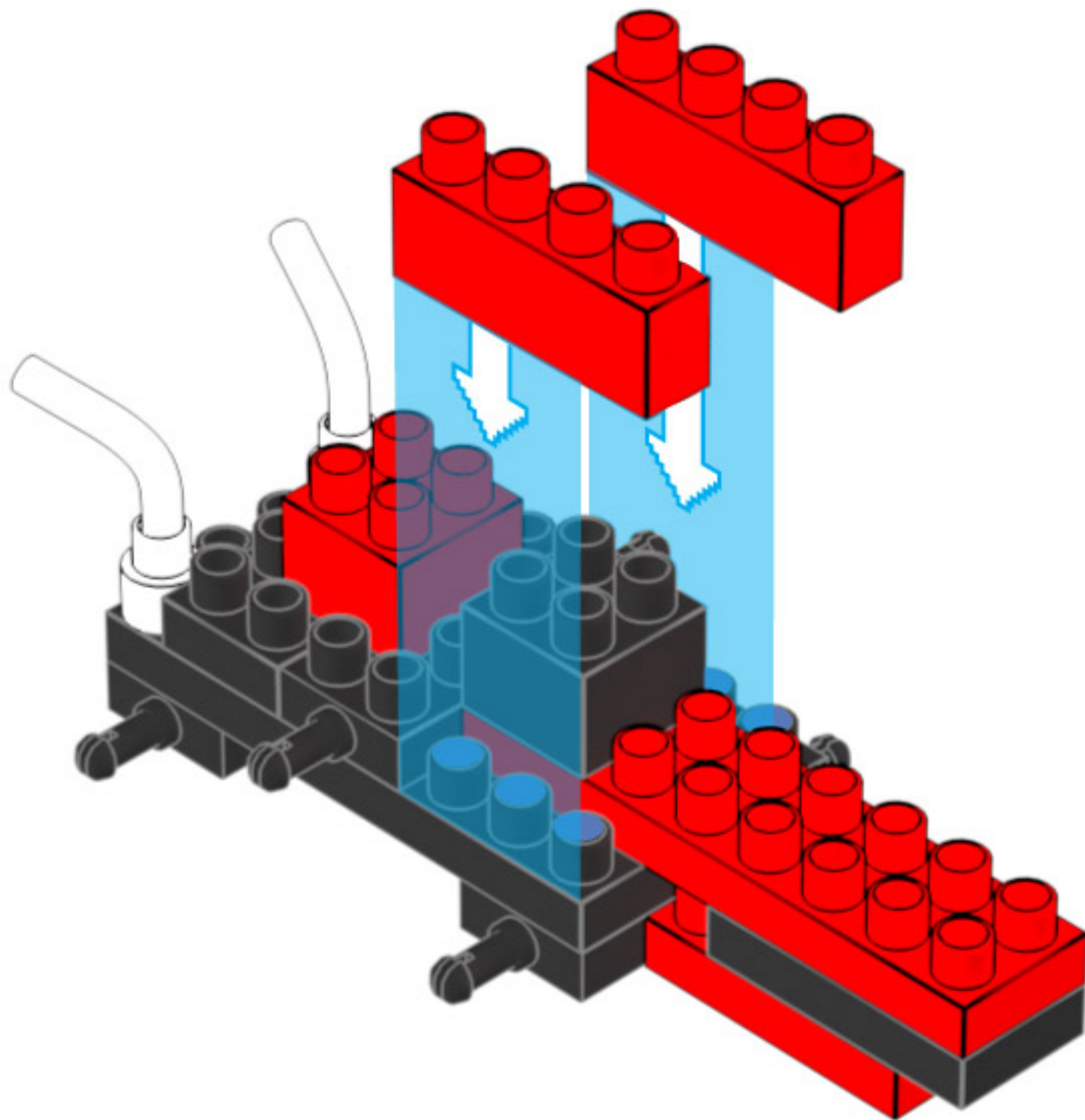

8

x1

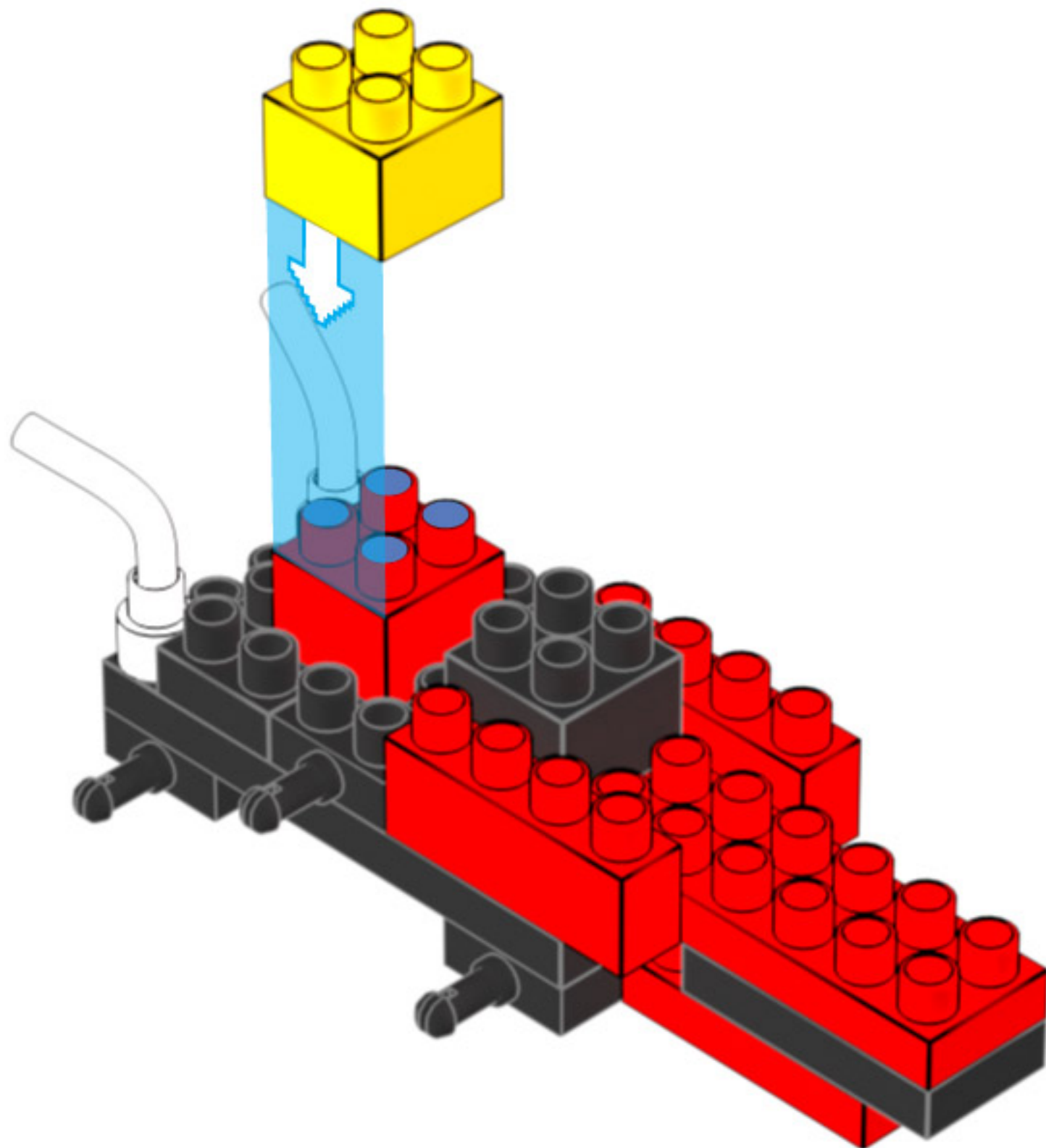

9

x2

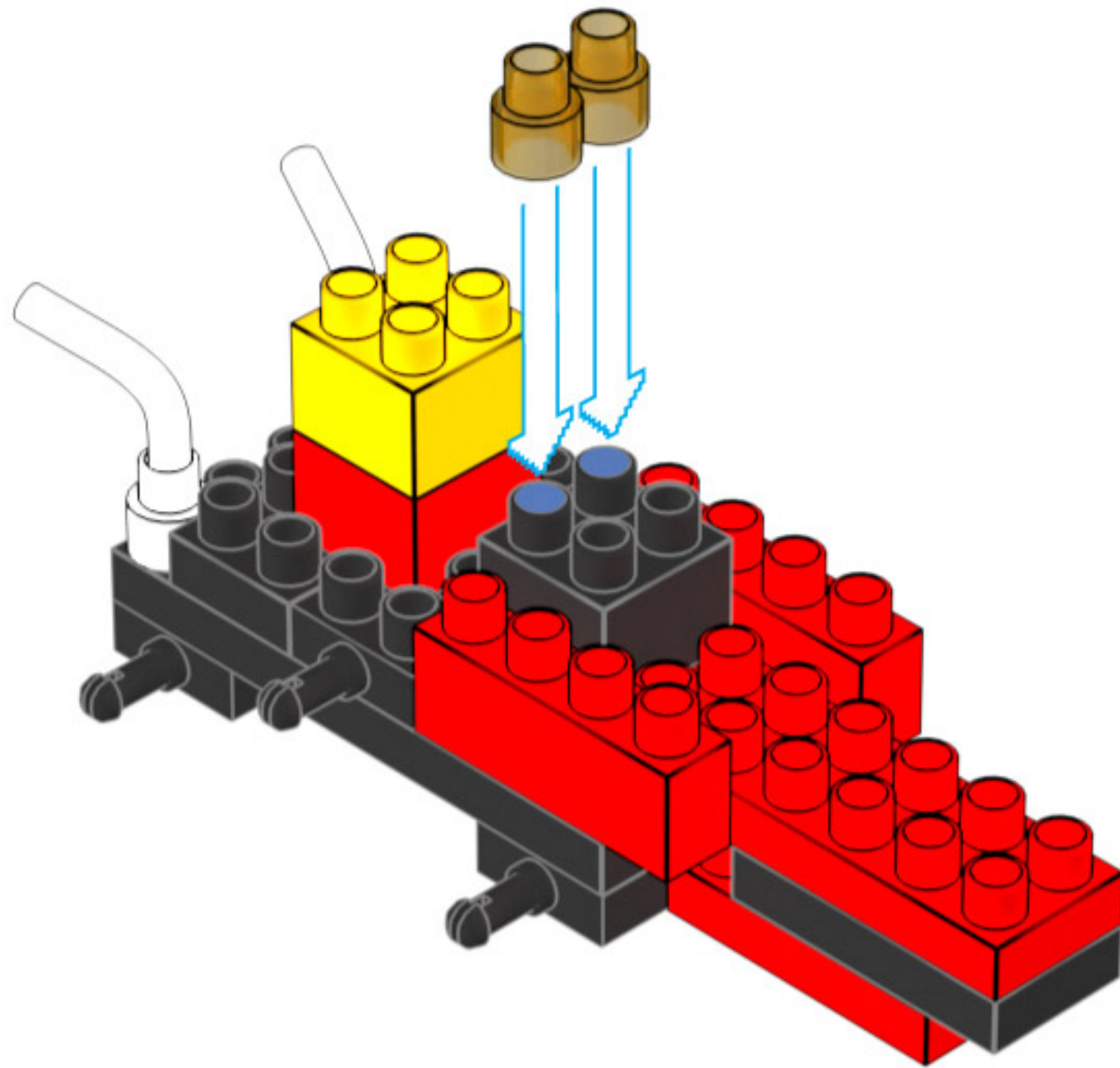

10

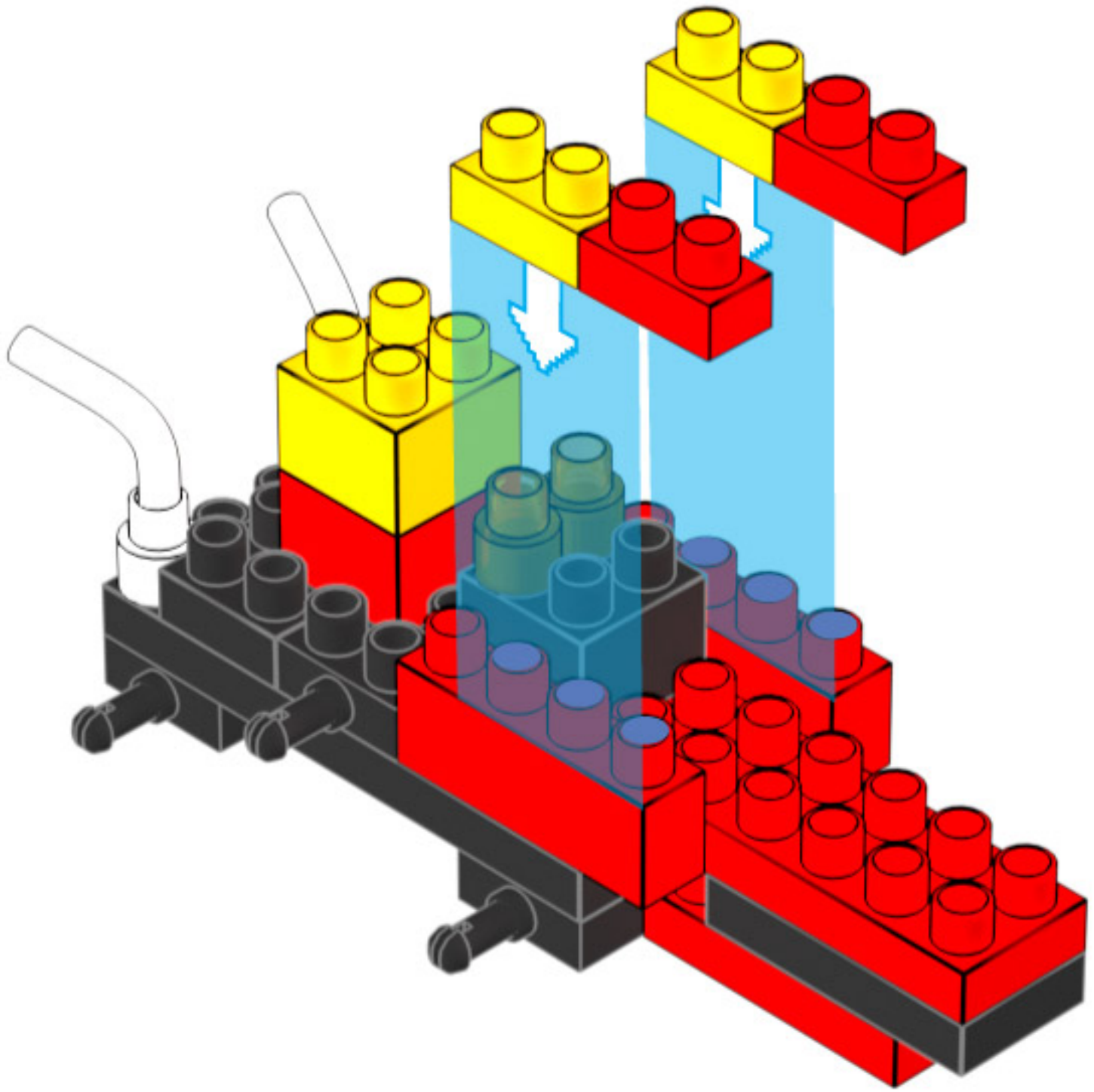
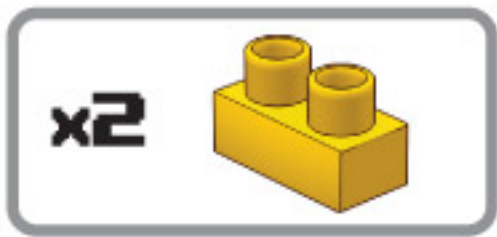

11

x1

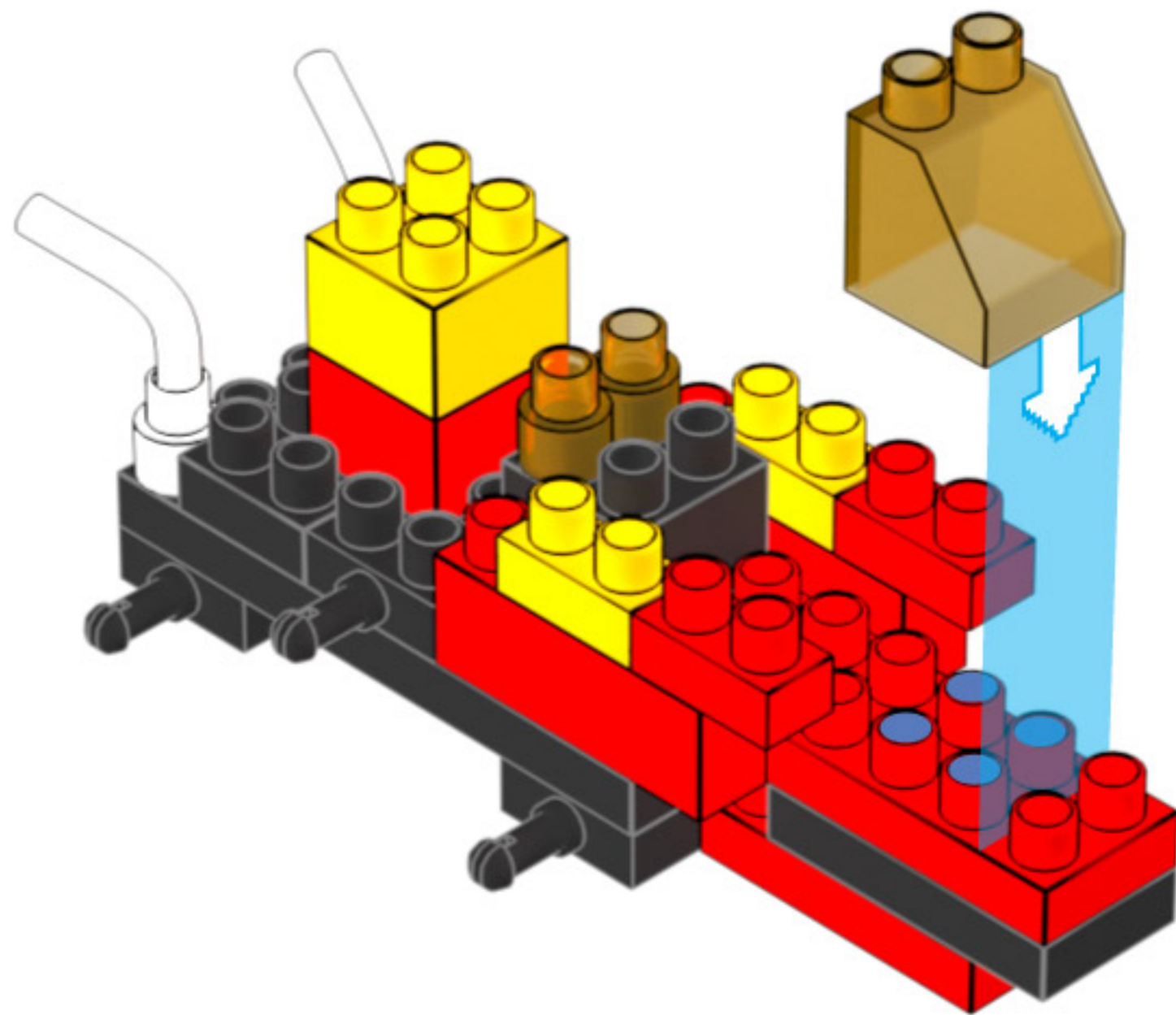

12

x2

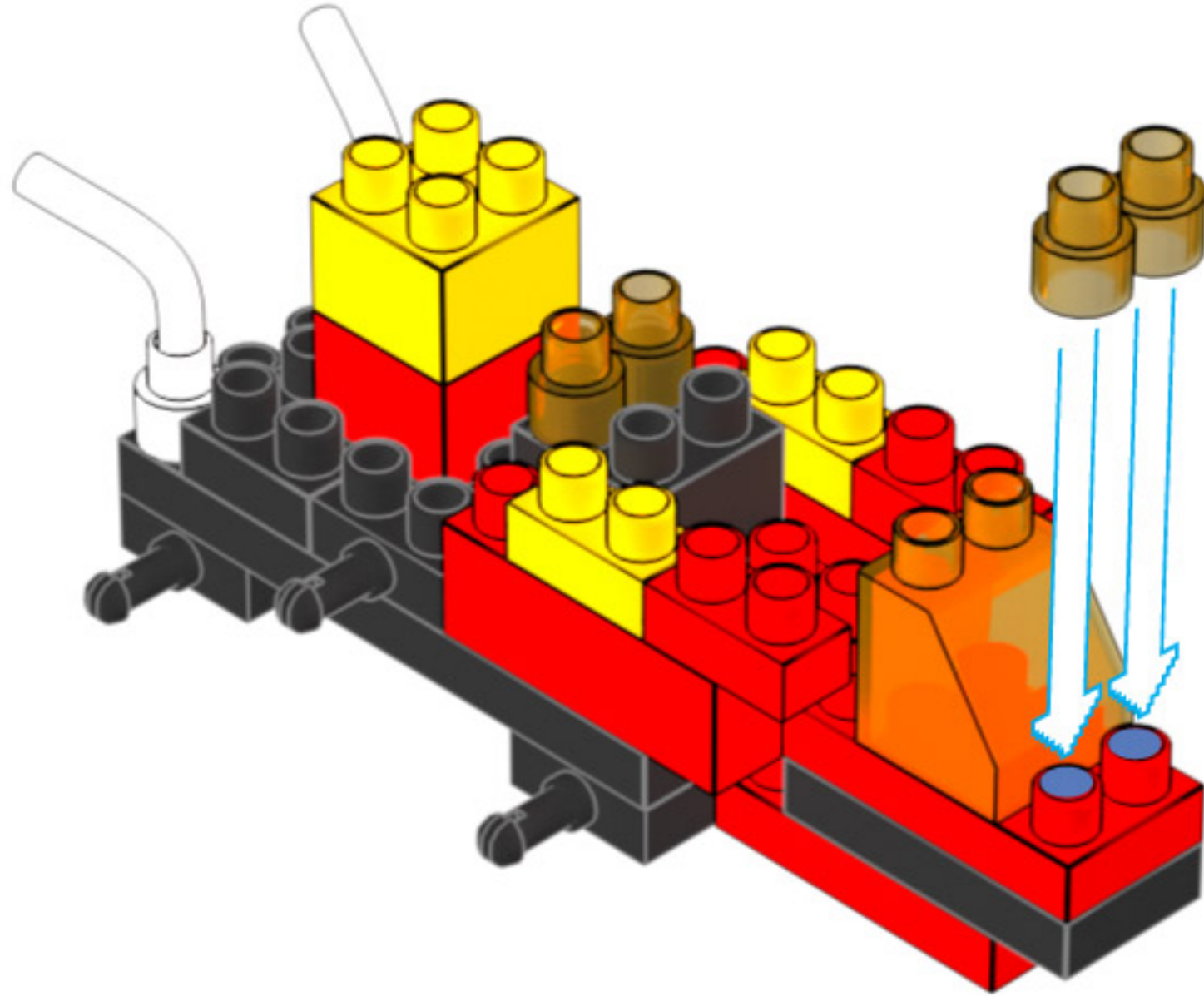

13

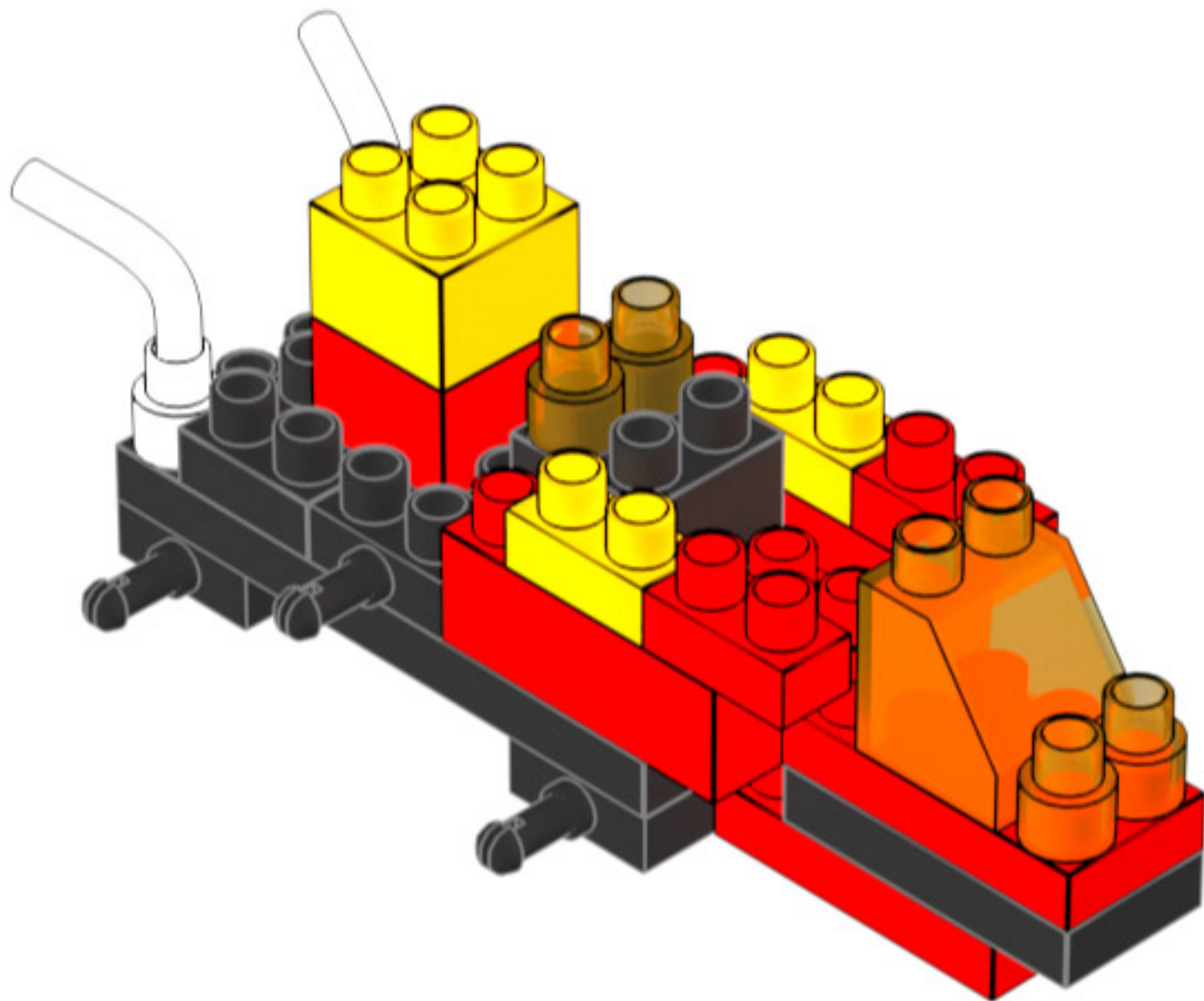

A

14

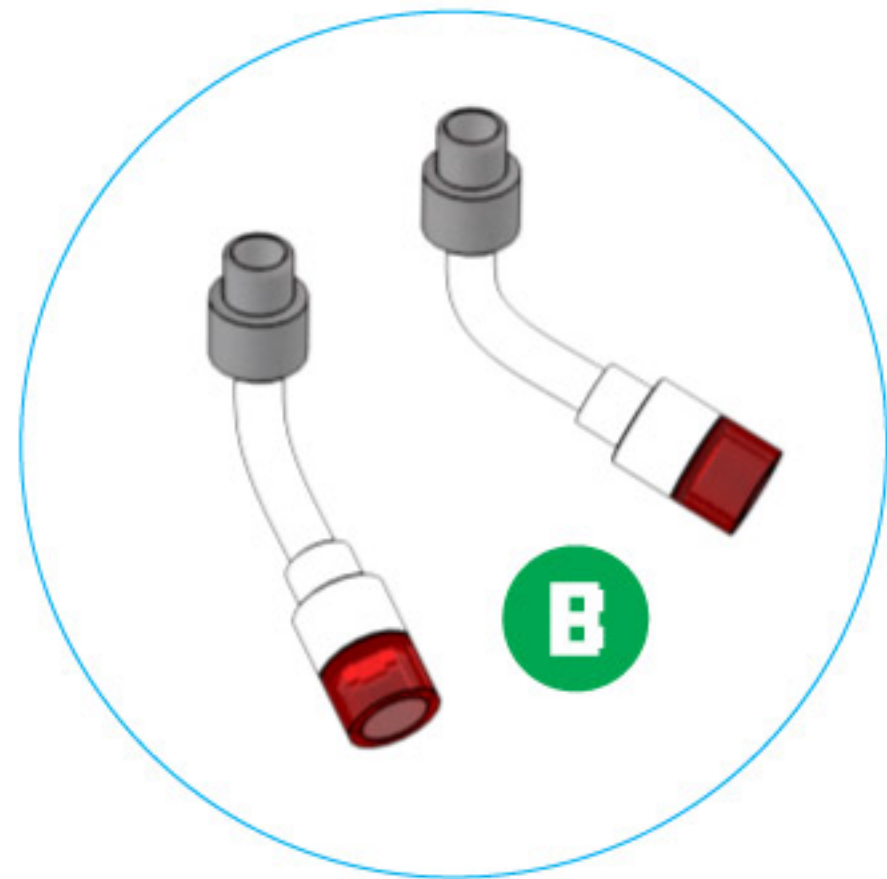
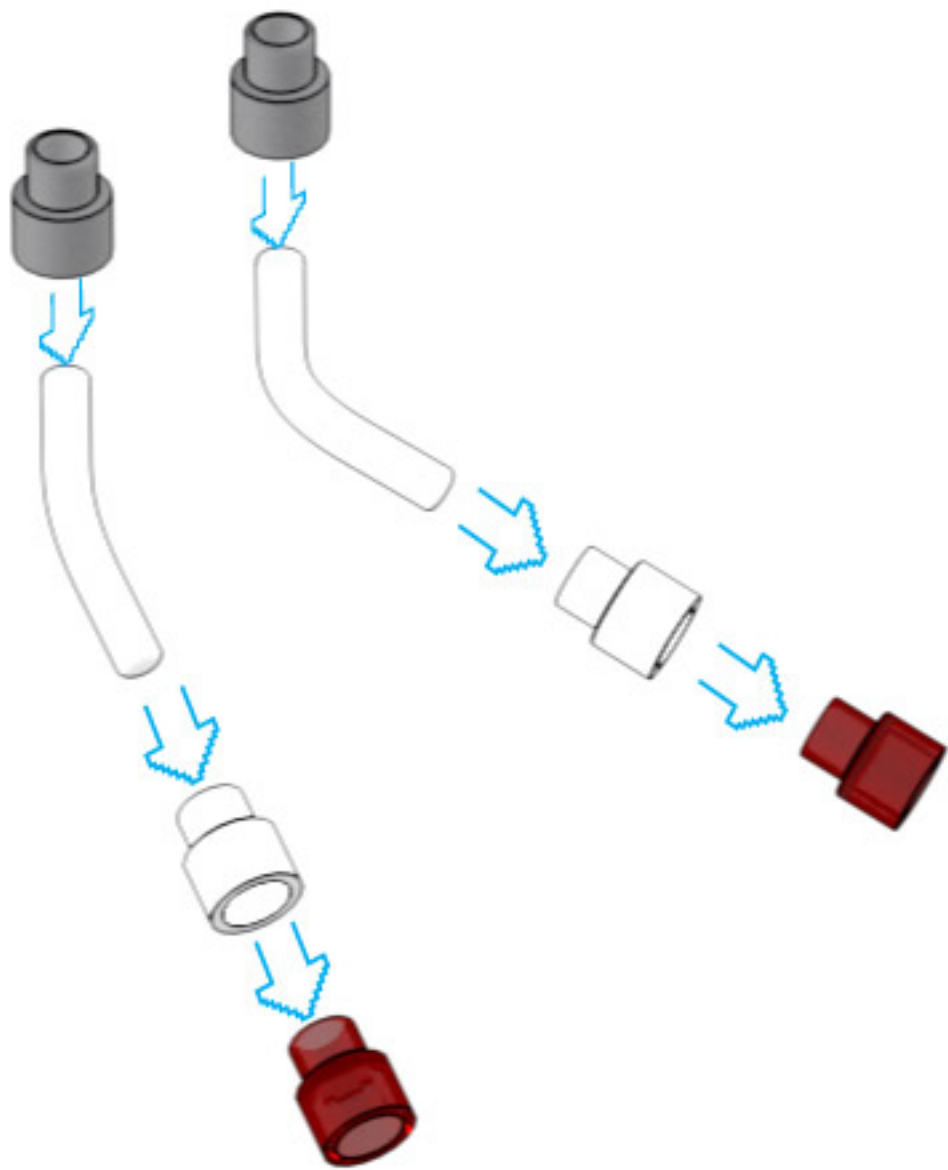

15

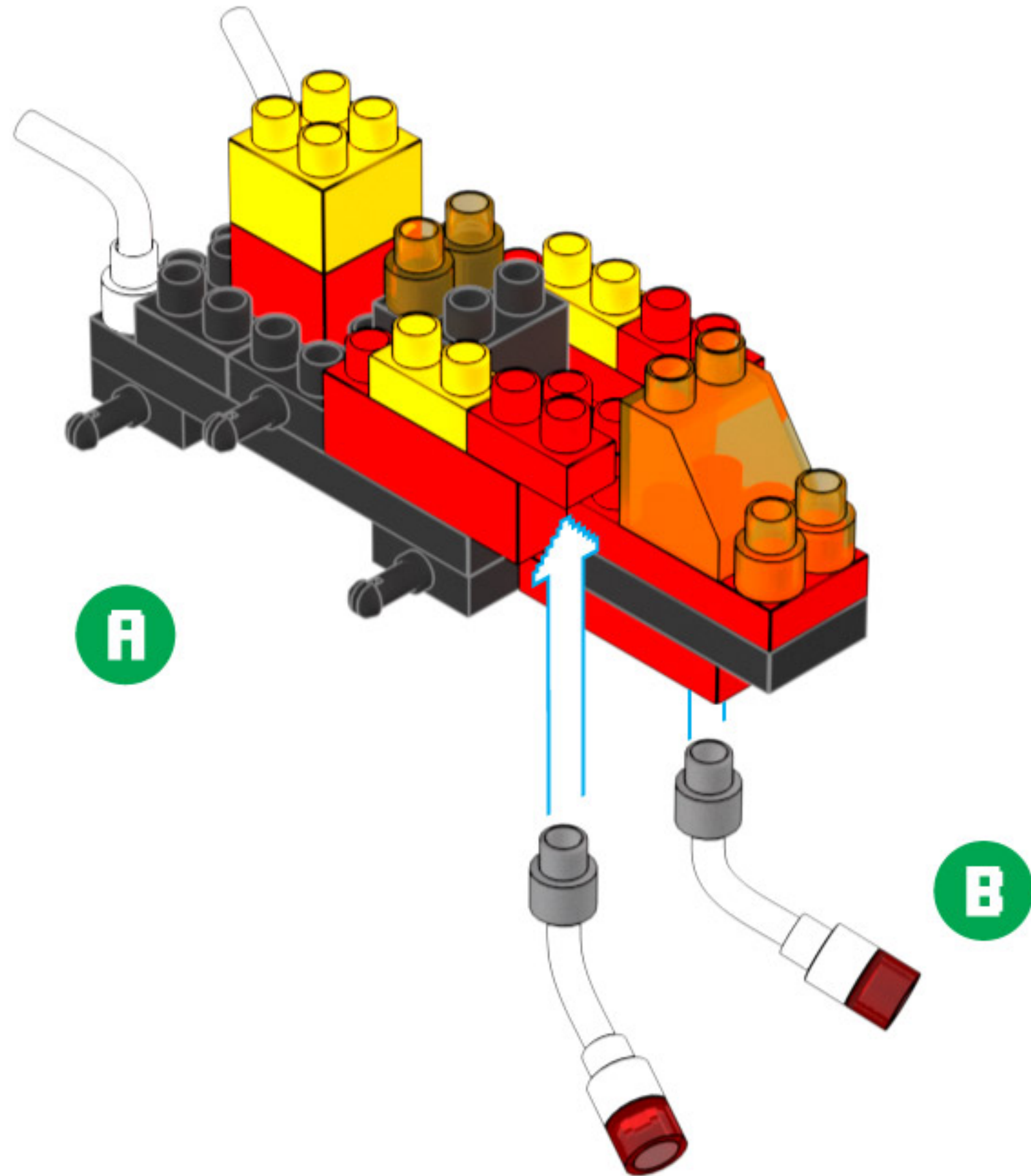

16

x6

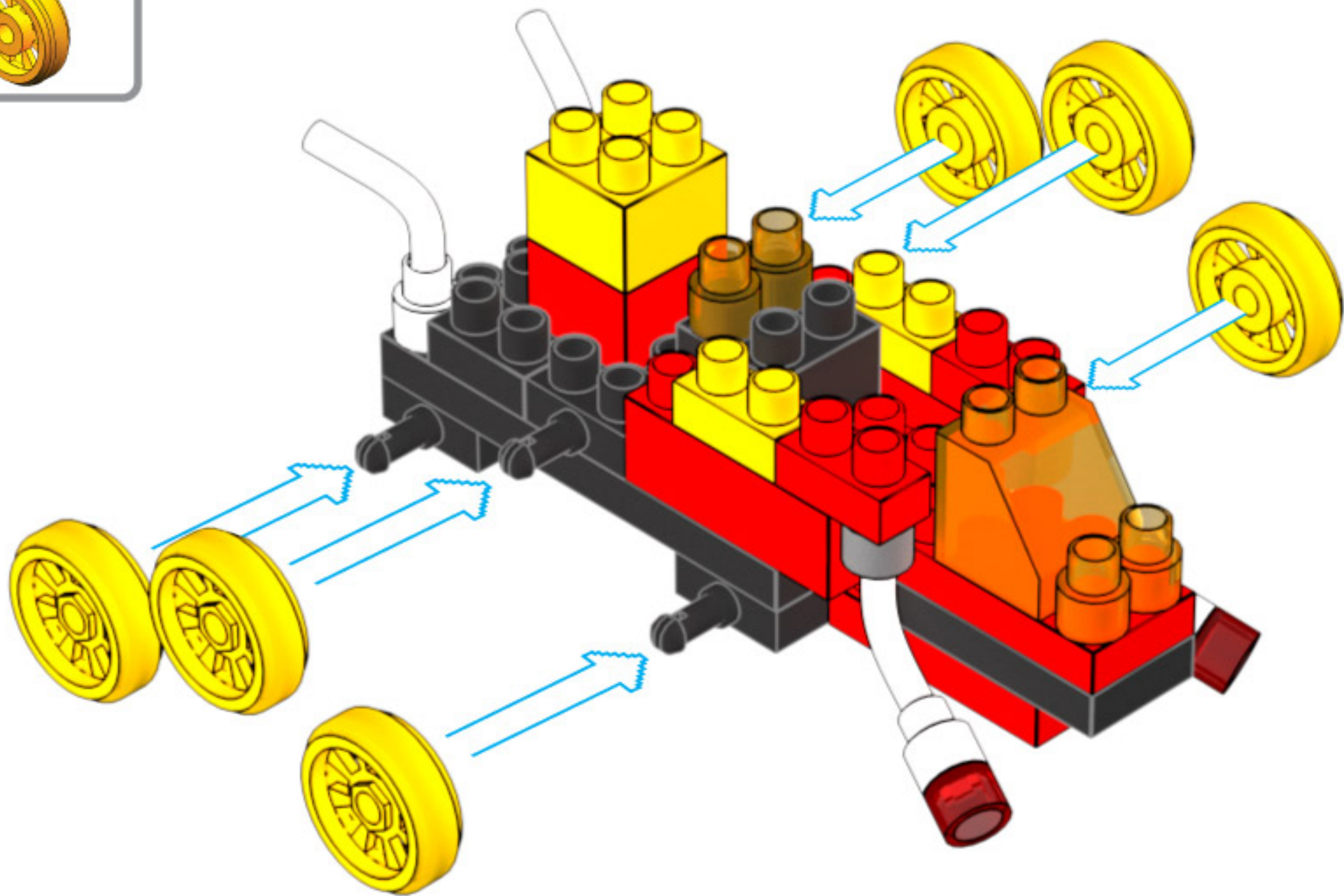

17

x2

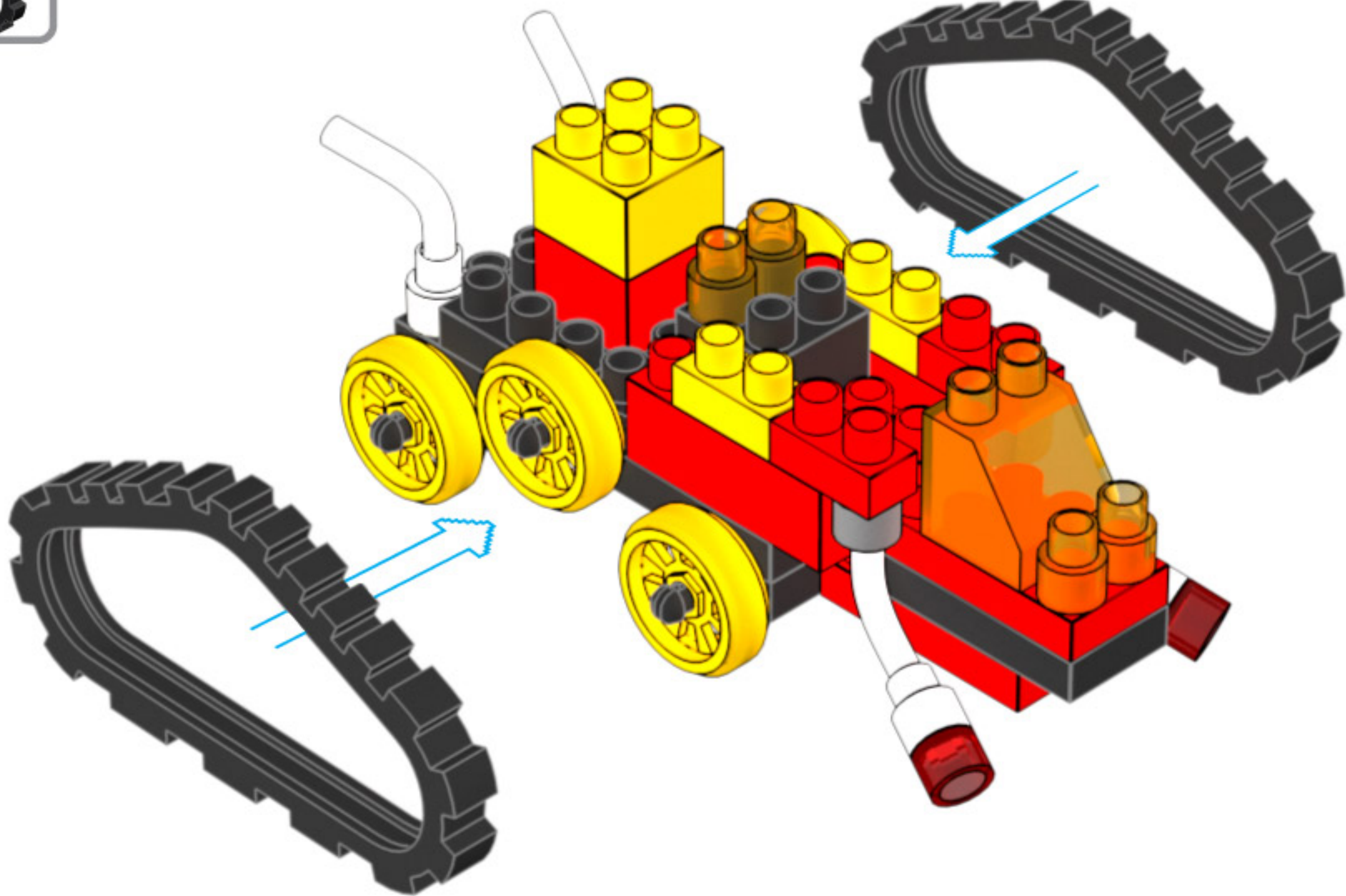

18

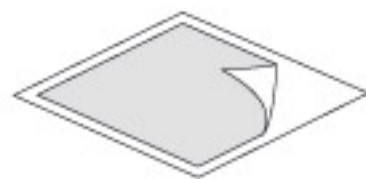

**PEGADO DE
STICKERS**



**PEGAR DE
AMBOS LADOS**



**PEGAR DE
AMBOS LADOS**

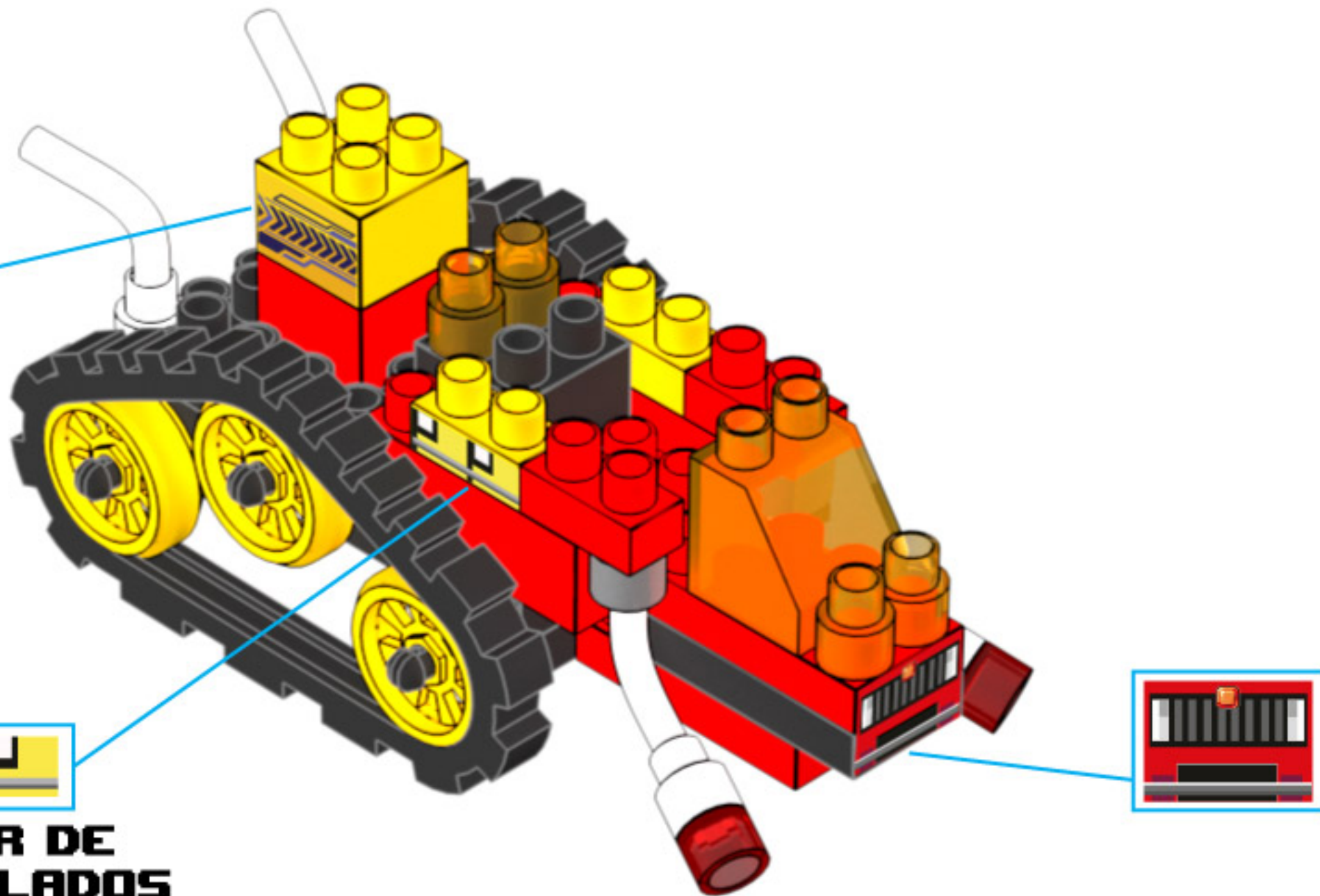

19 **MODELO TERMINADO**

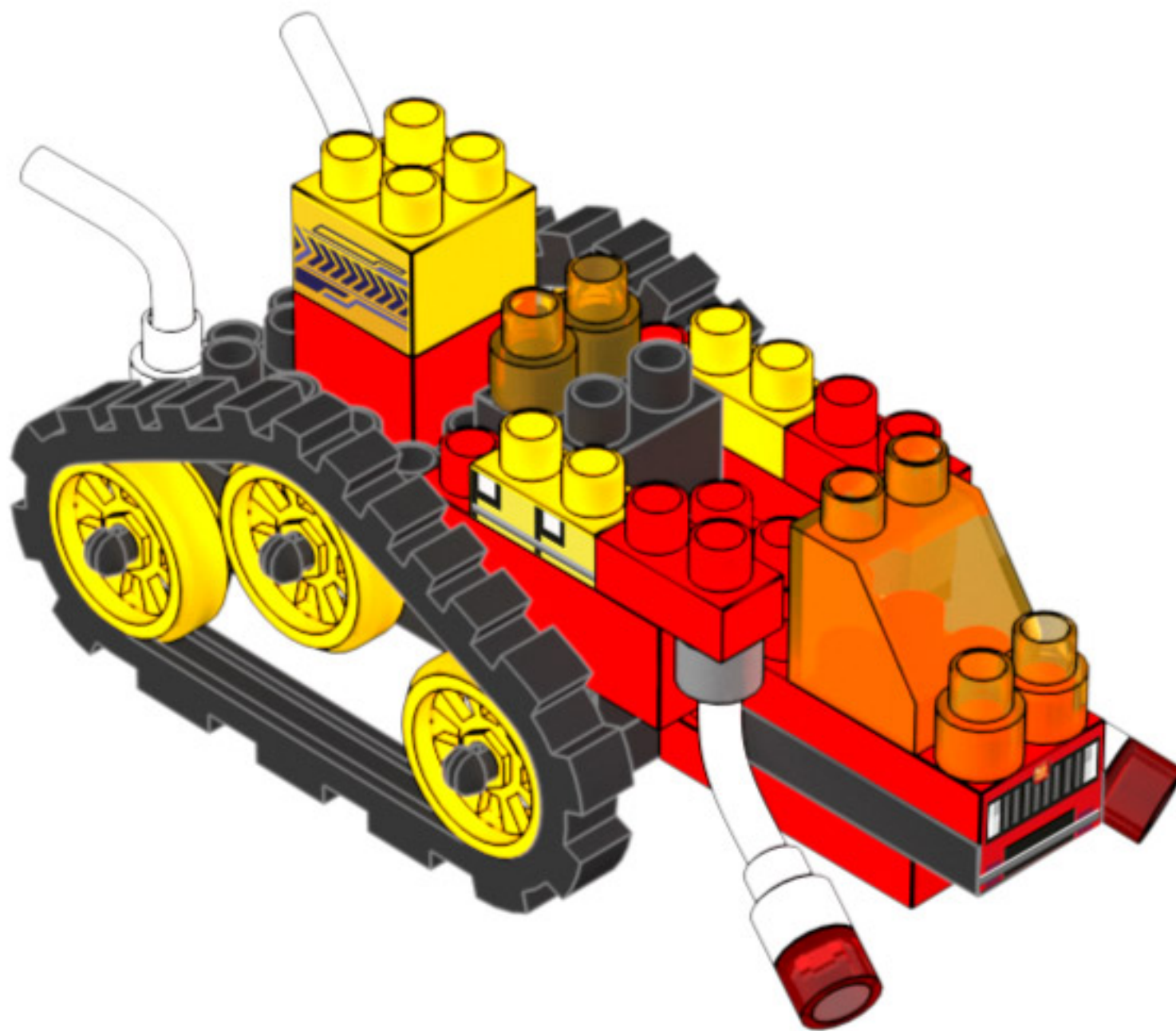

APA



I

x1



x2



x2

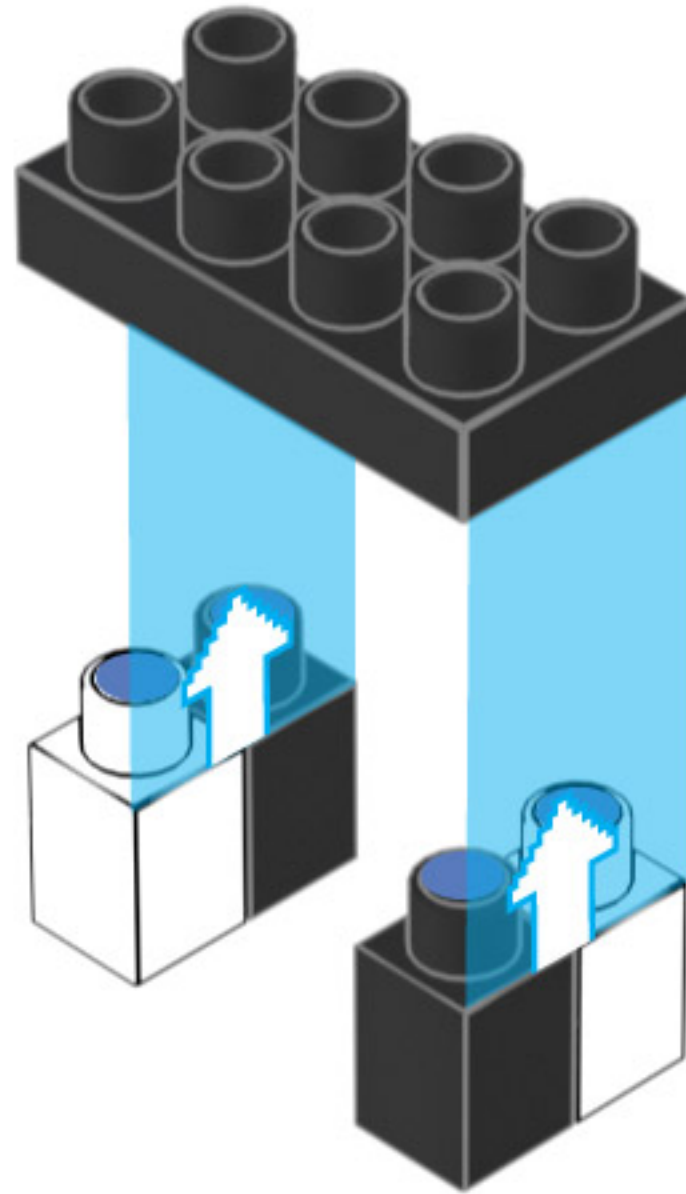

2

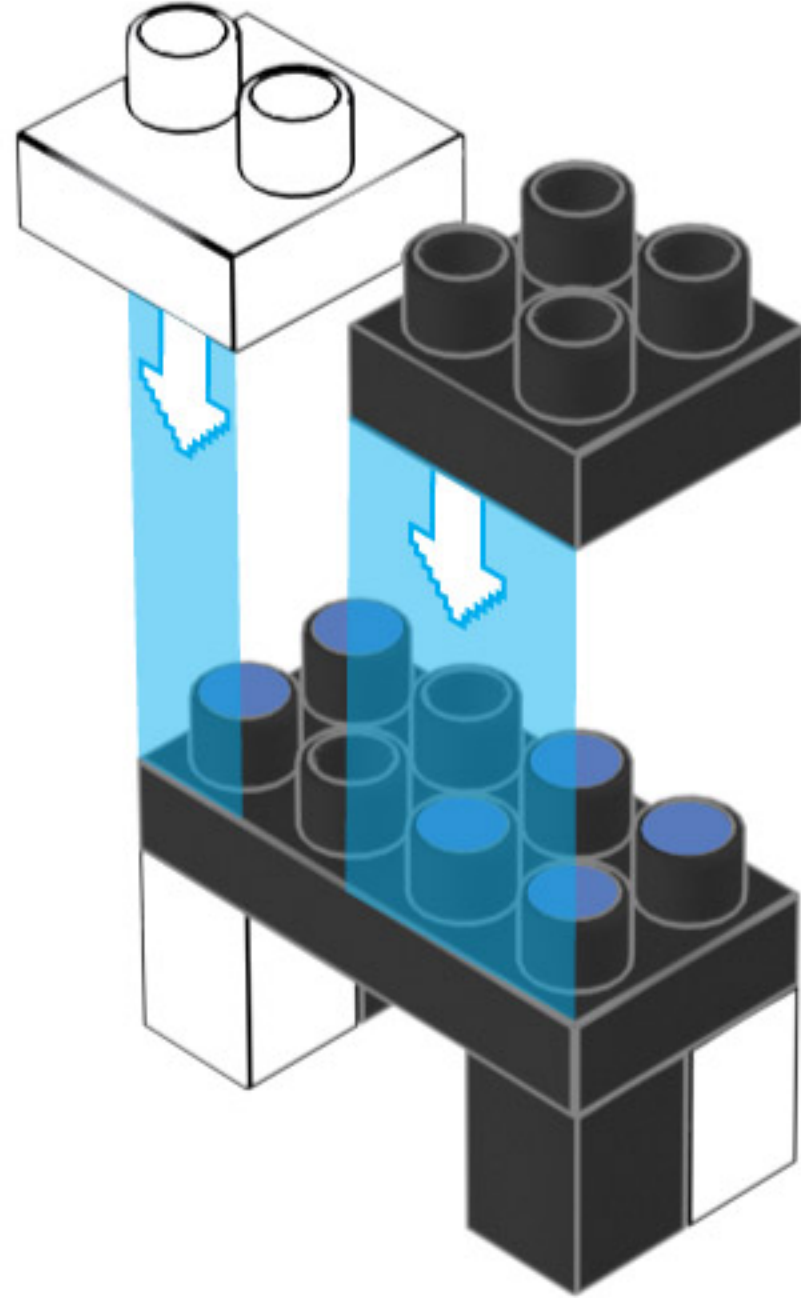
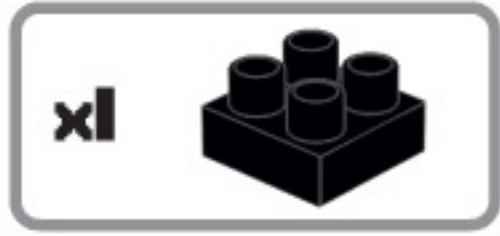
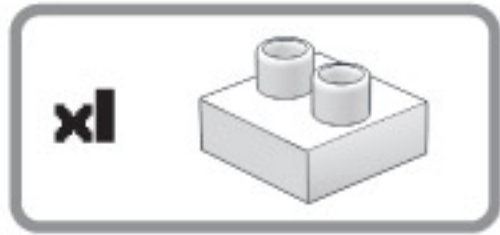

3

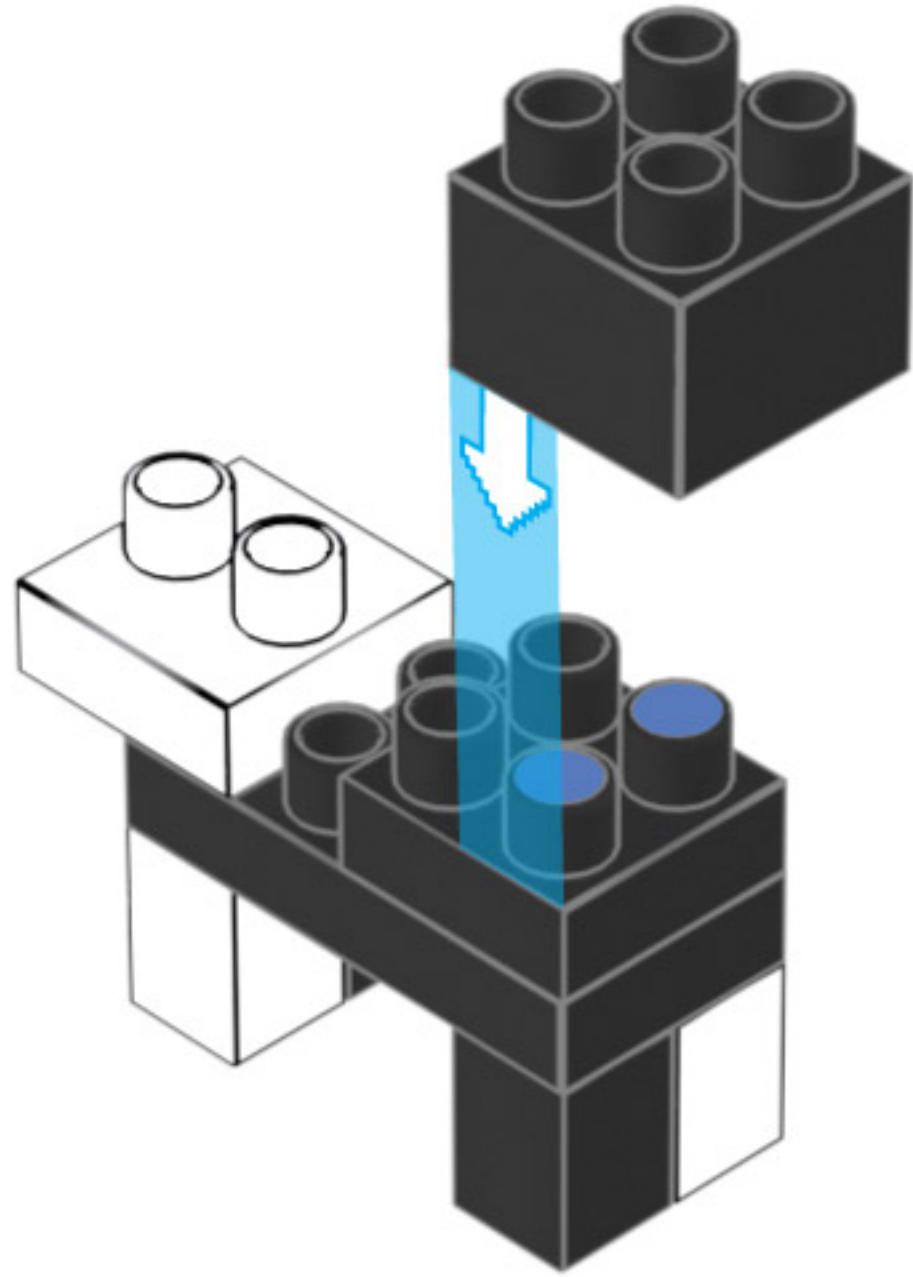
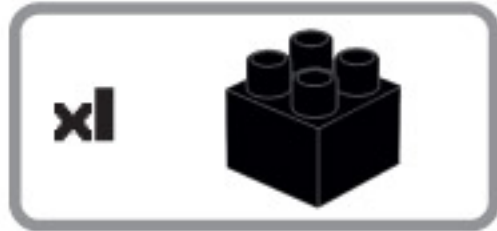

4

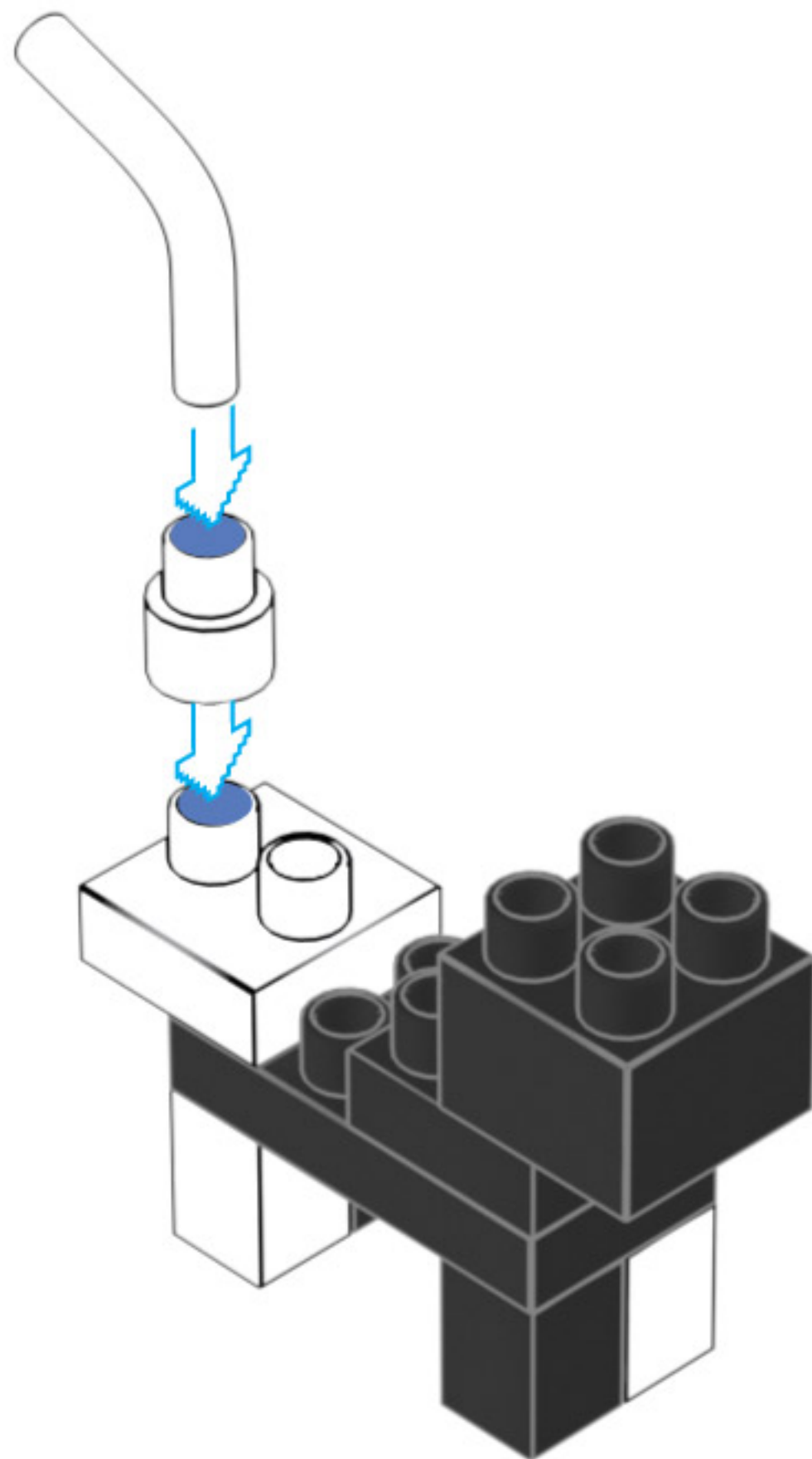
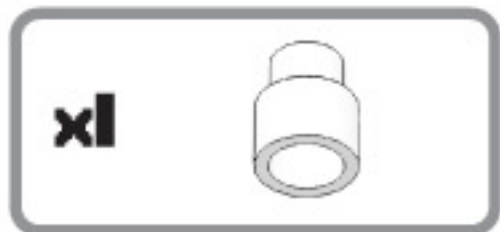

5

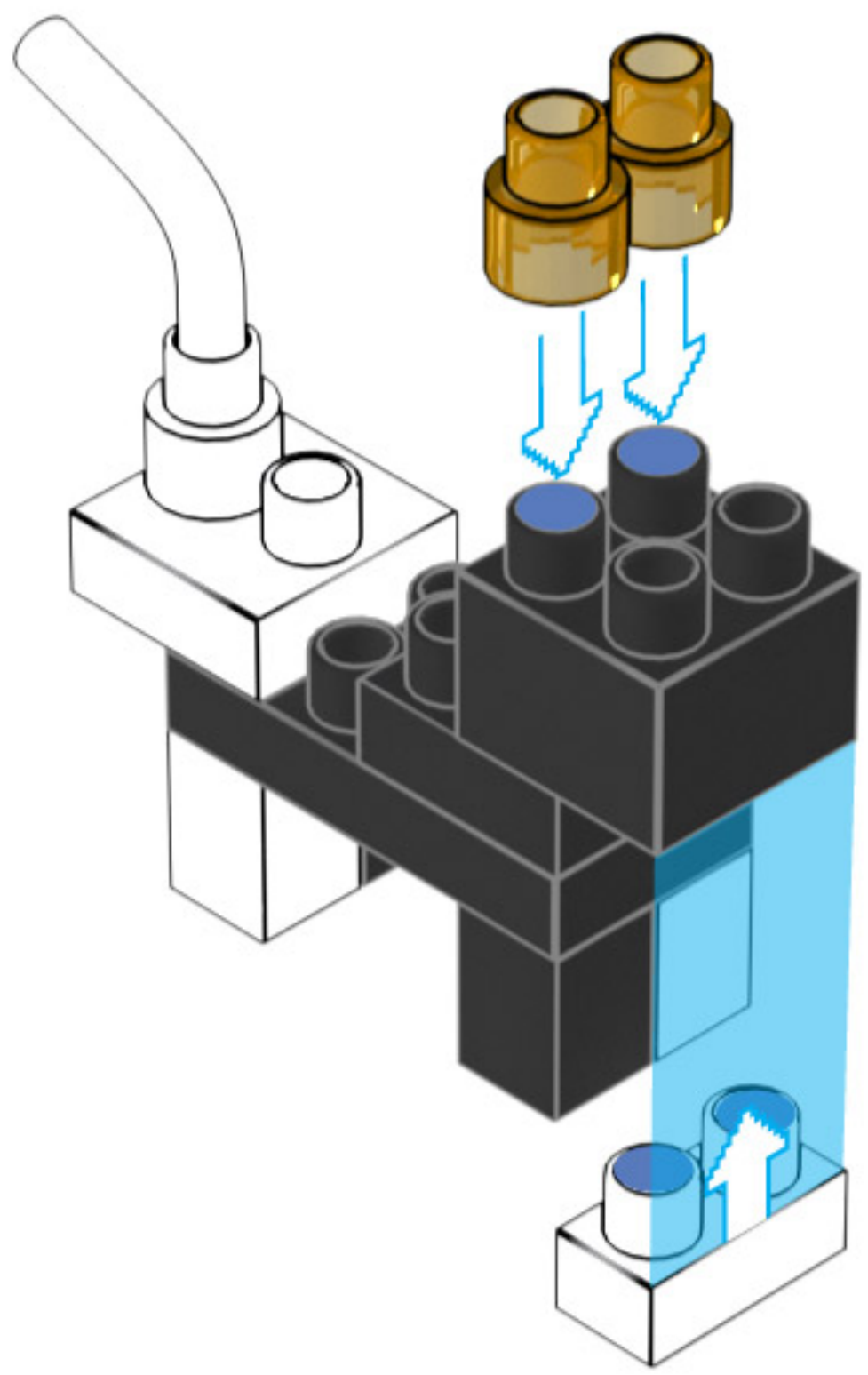
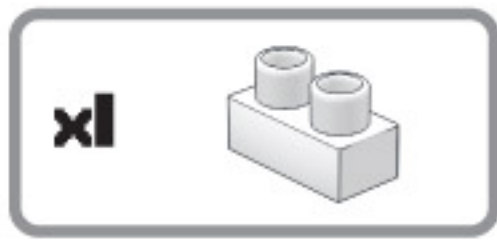

6

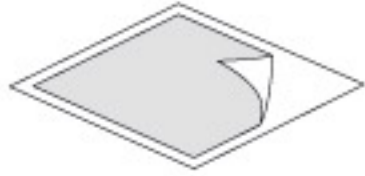

**PEGADO DE
STICKERS**

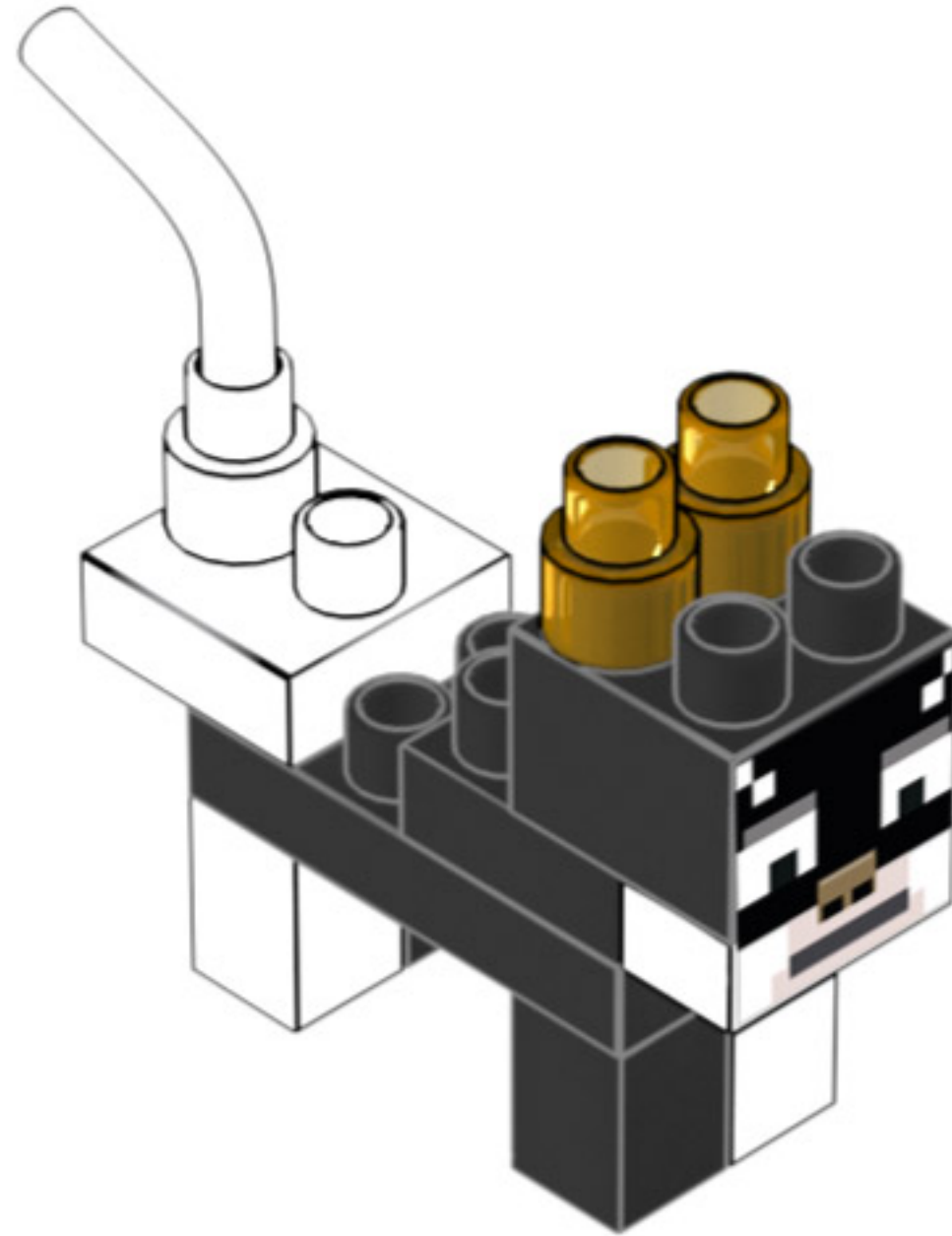

7

MODELO TERMINADO

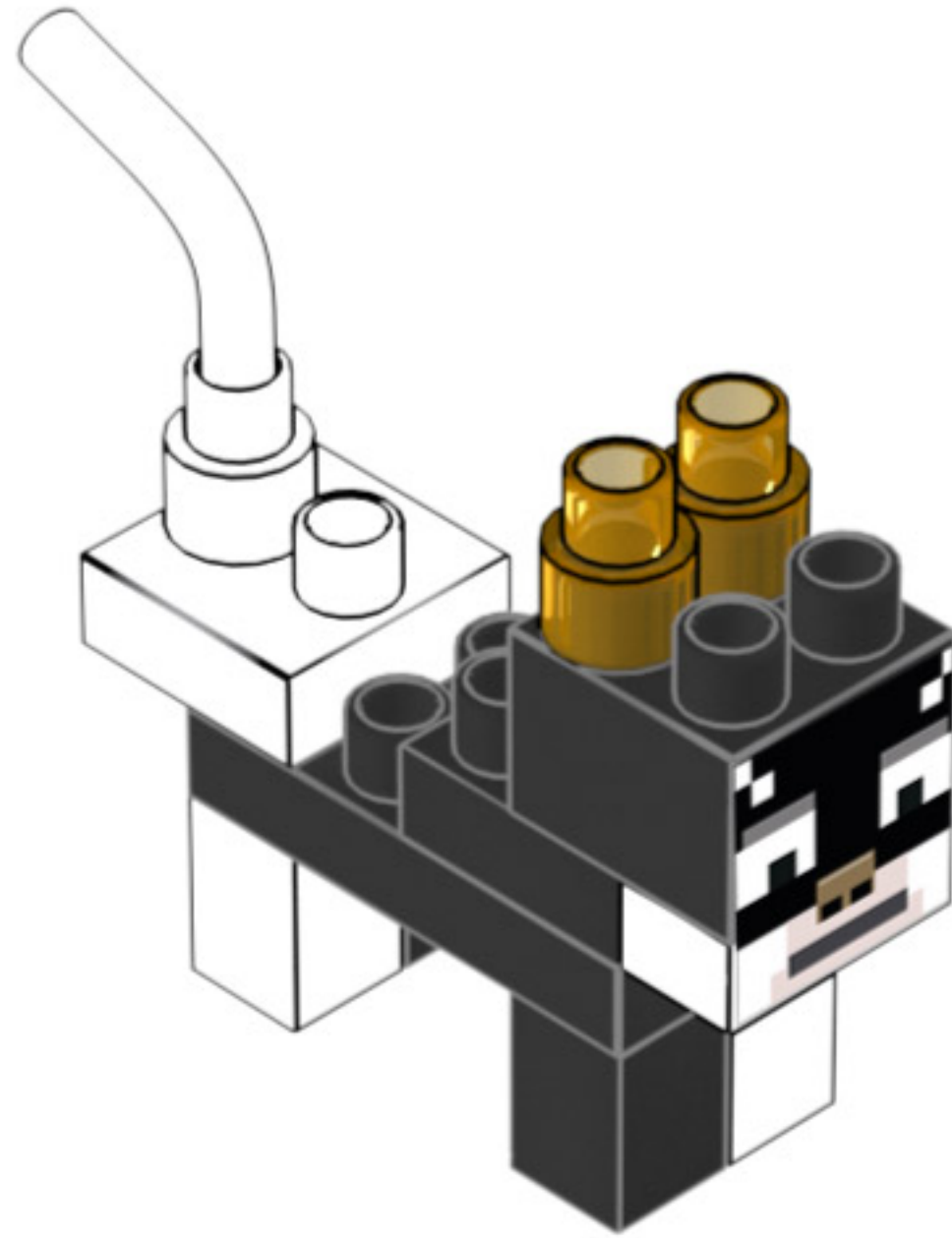



GROTUS

1

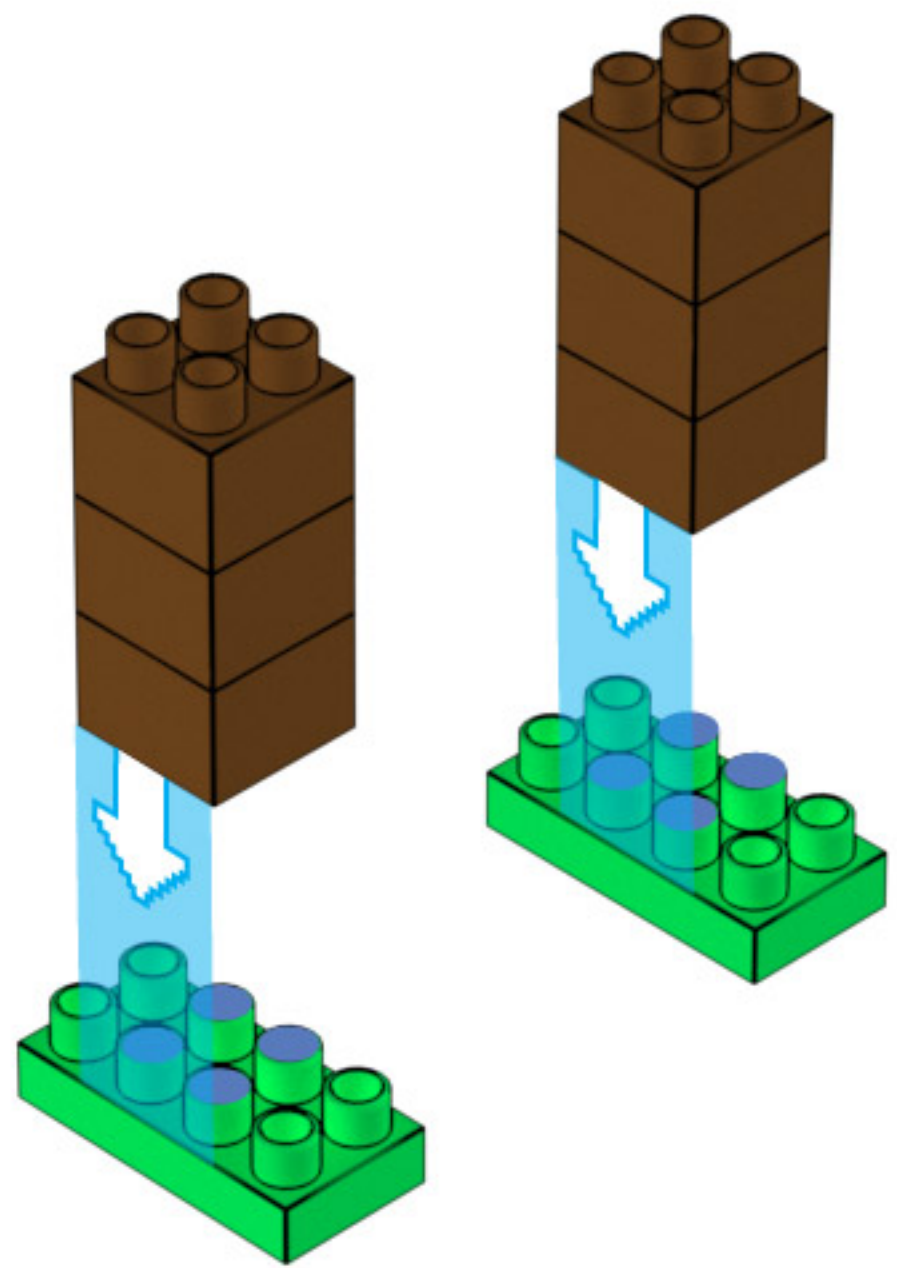

2

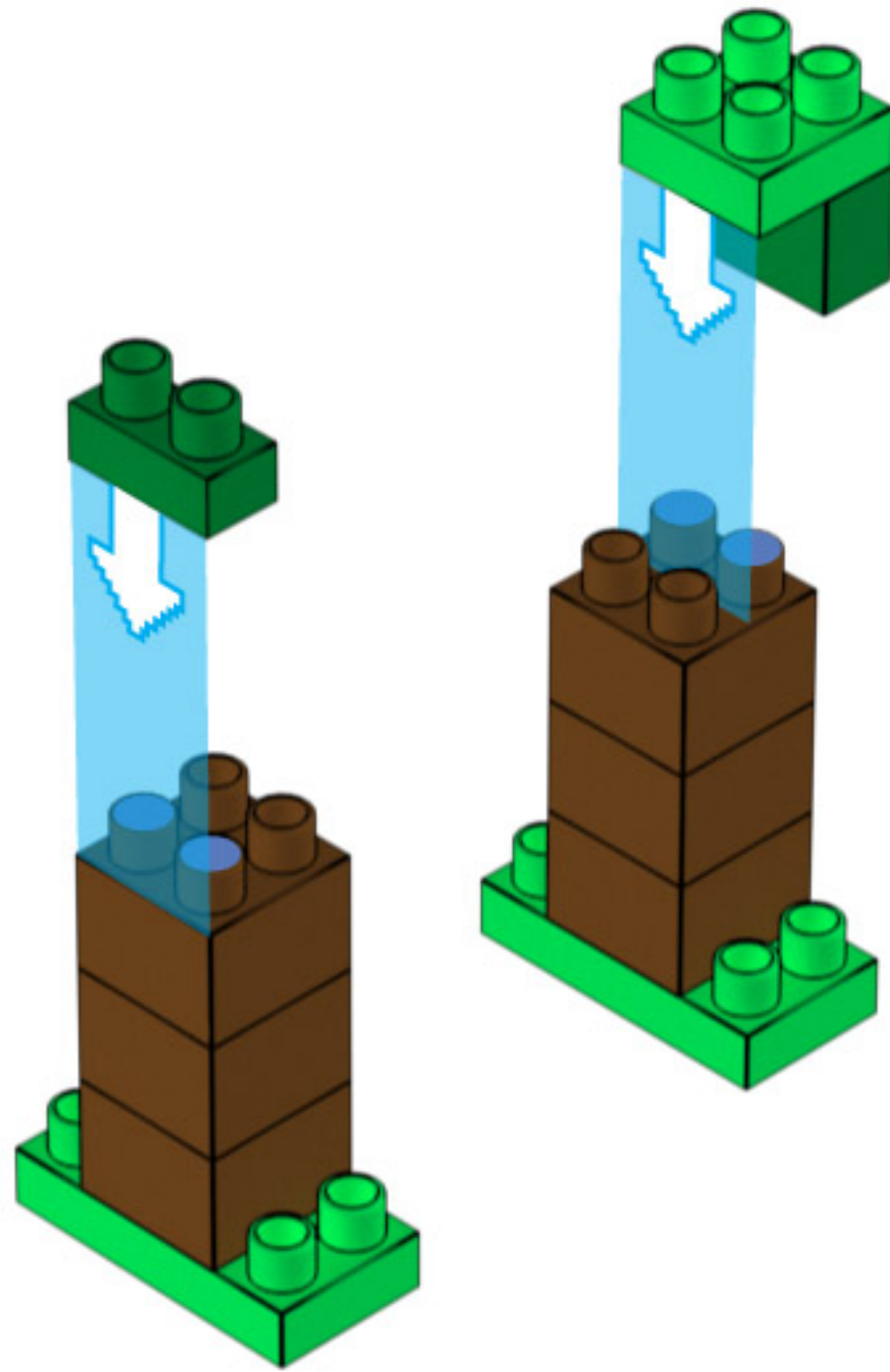
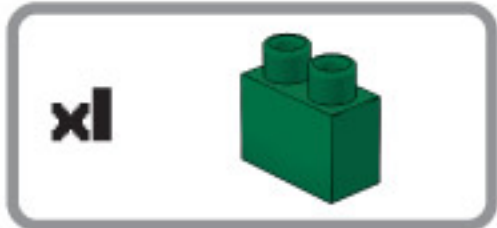
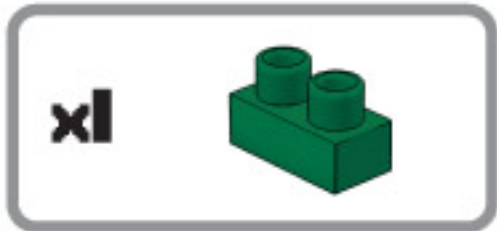

3

x2

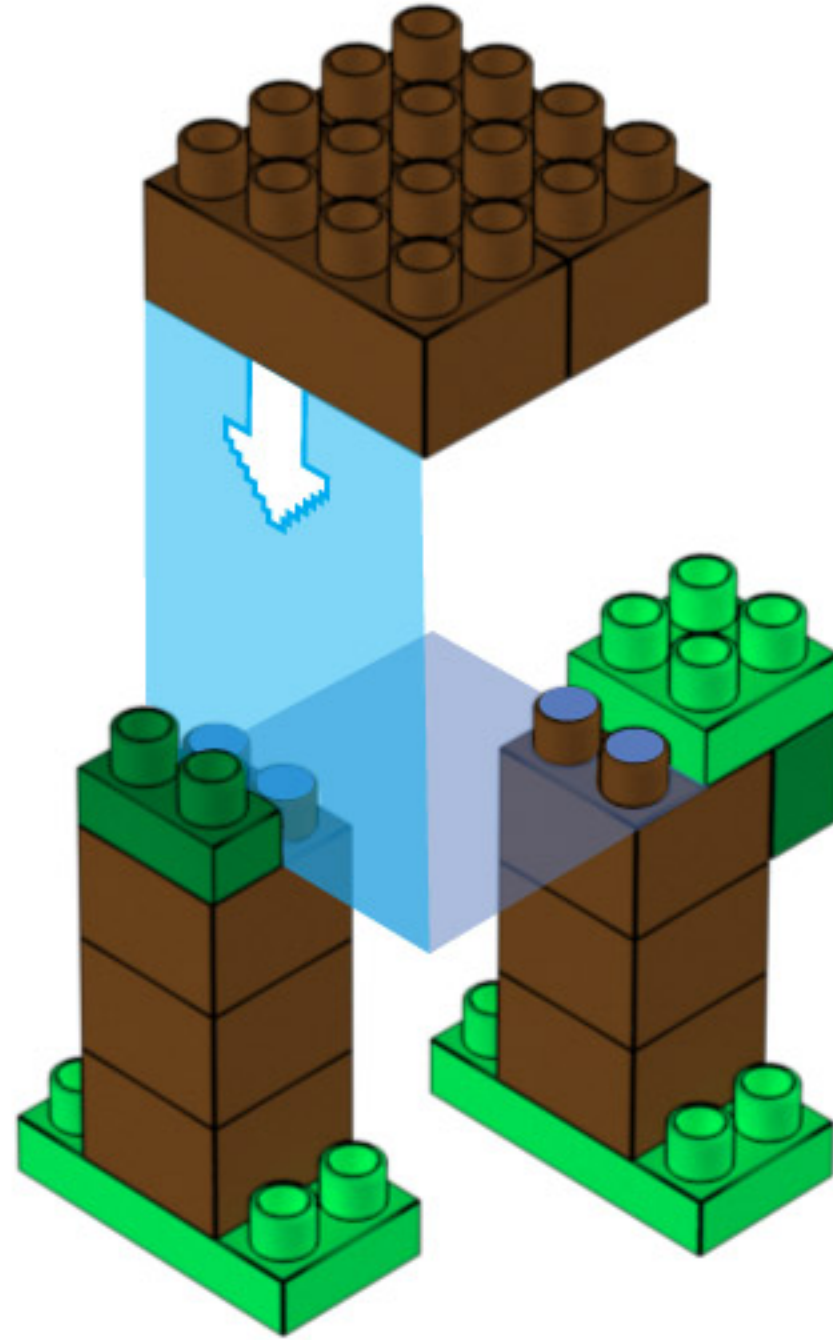

4

x2

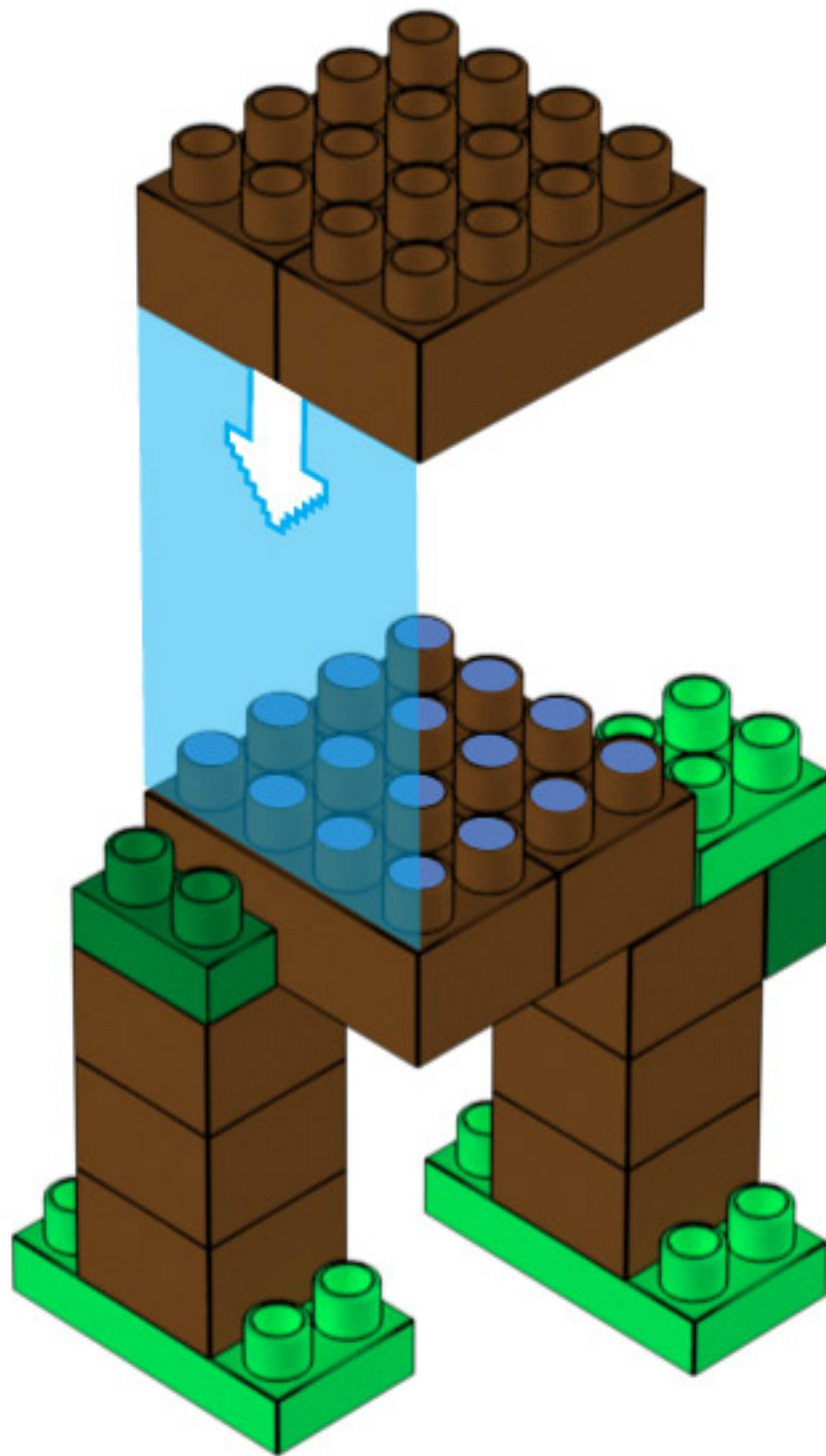

5

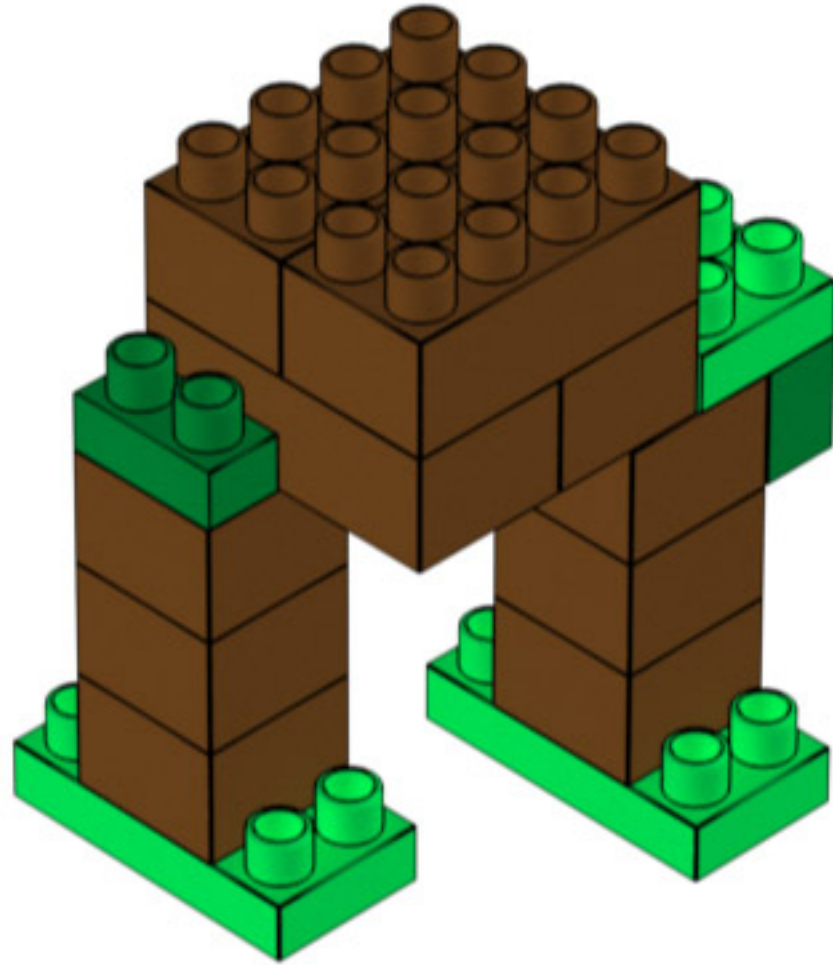

A

6

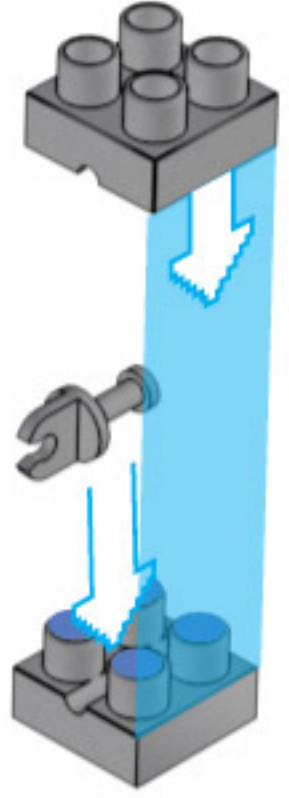
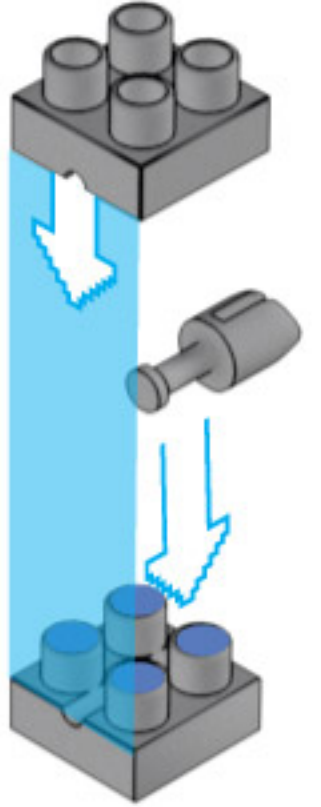
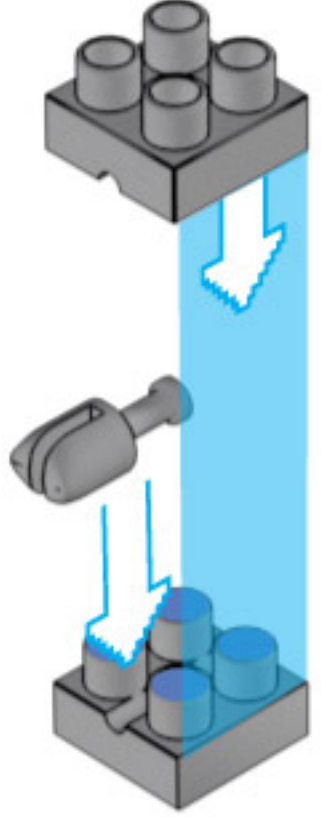
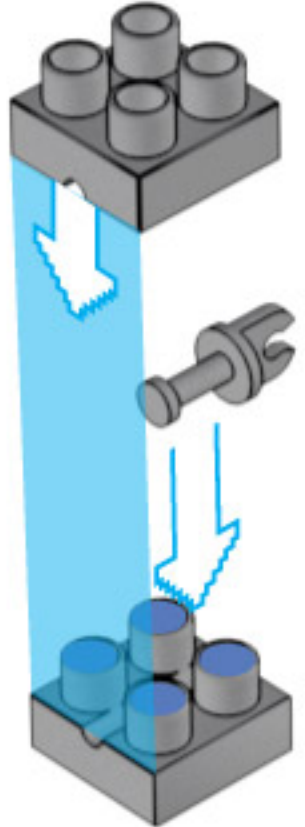
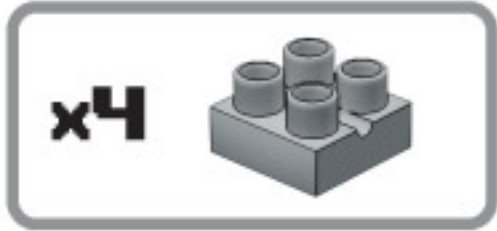

7

x4

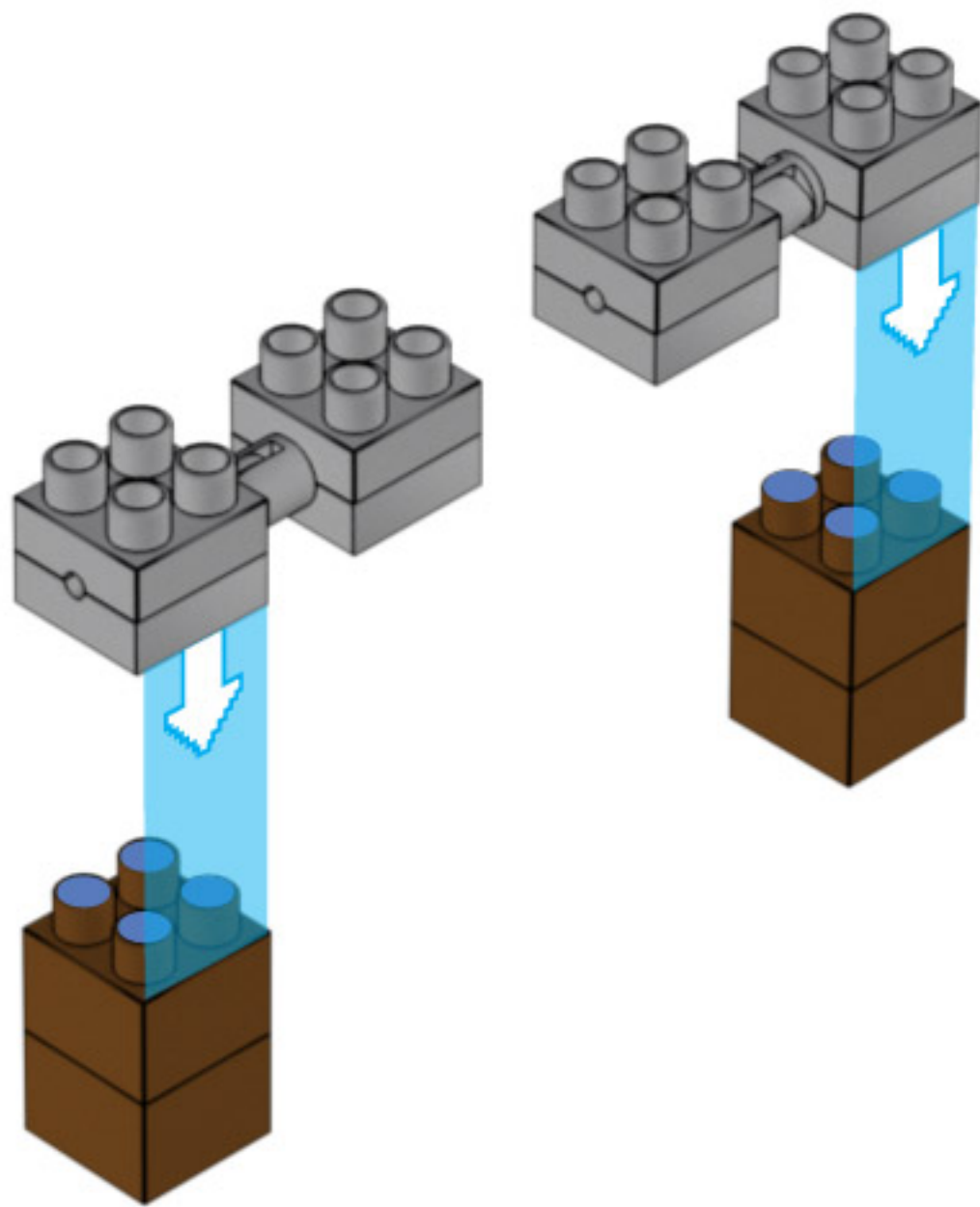

8

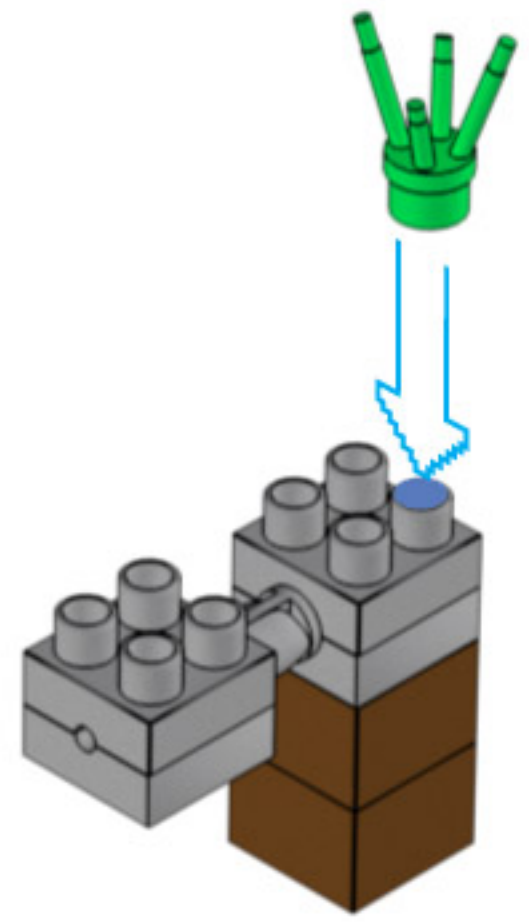
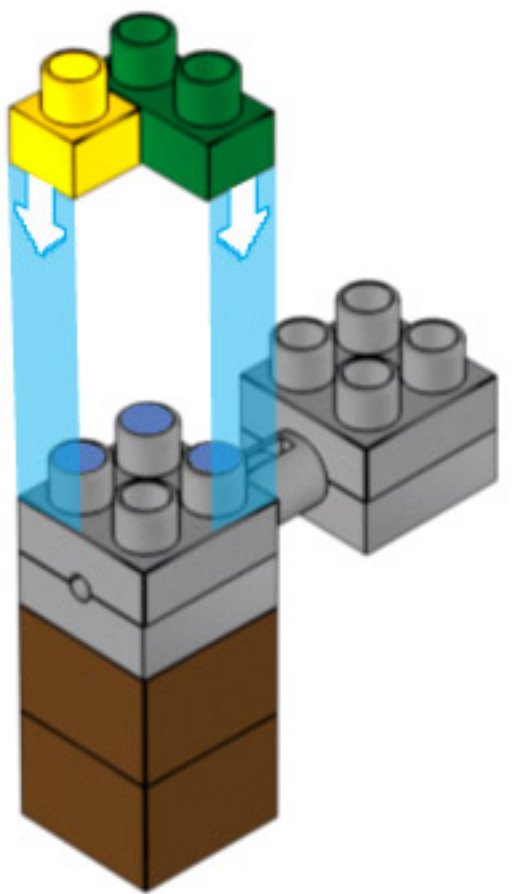
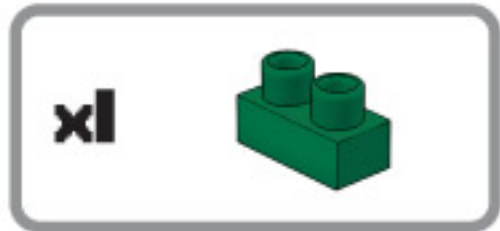
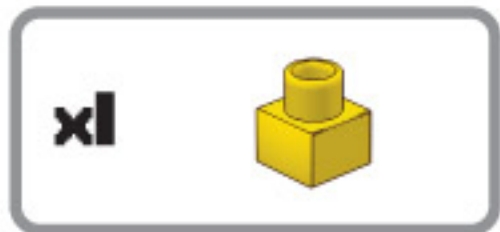

B

9

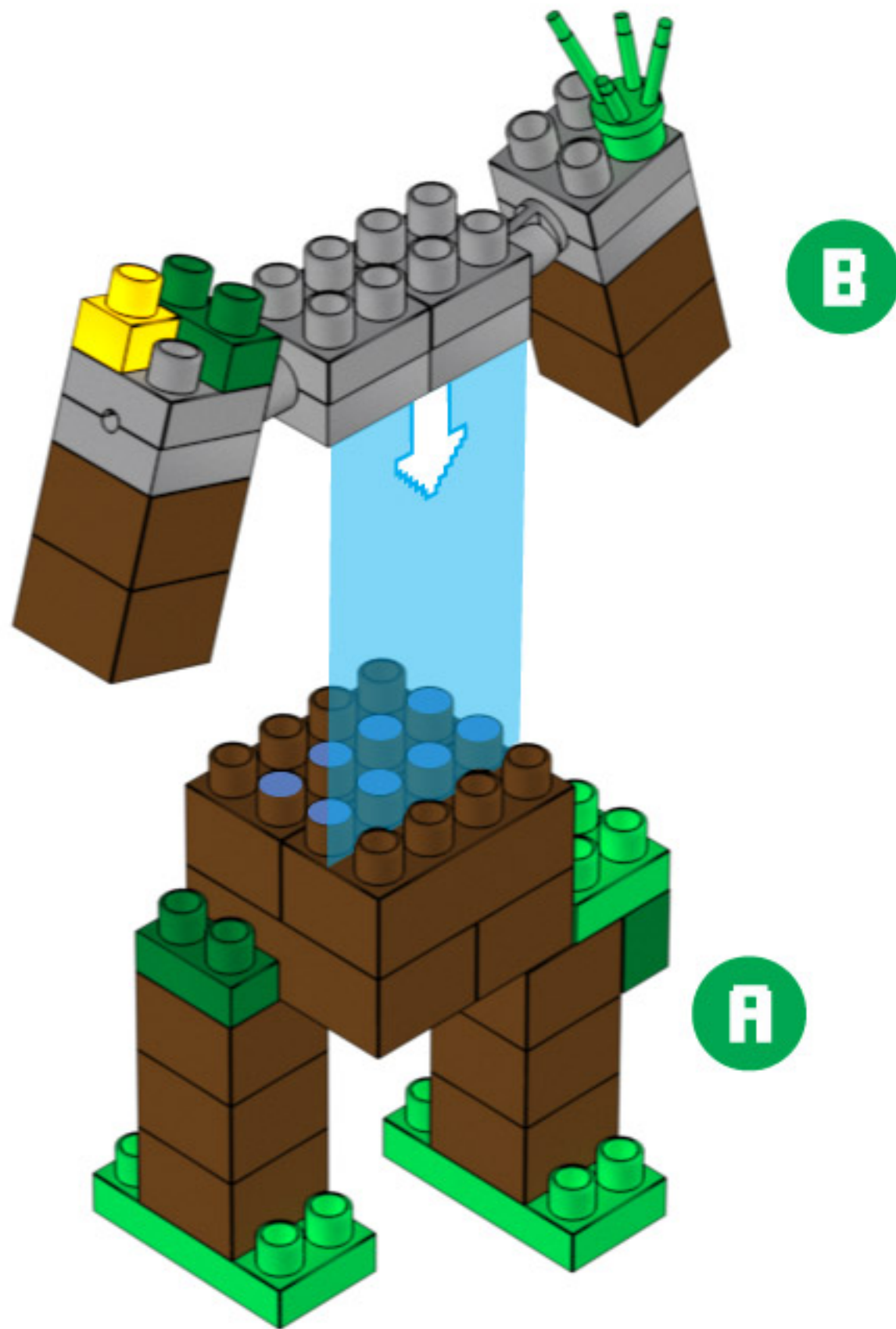

B

A

10

x1

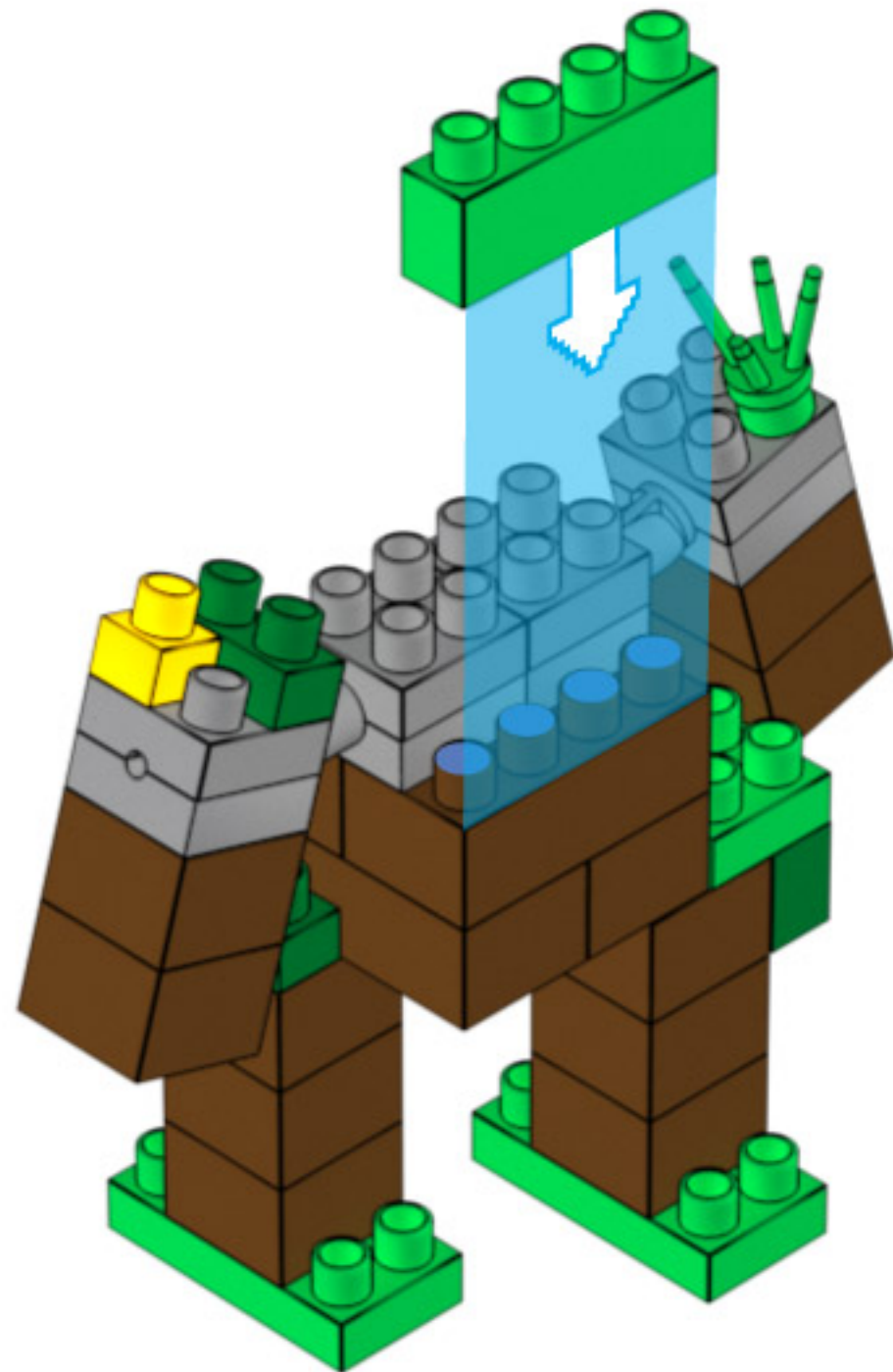

11

x1

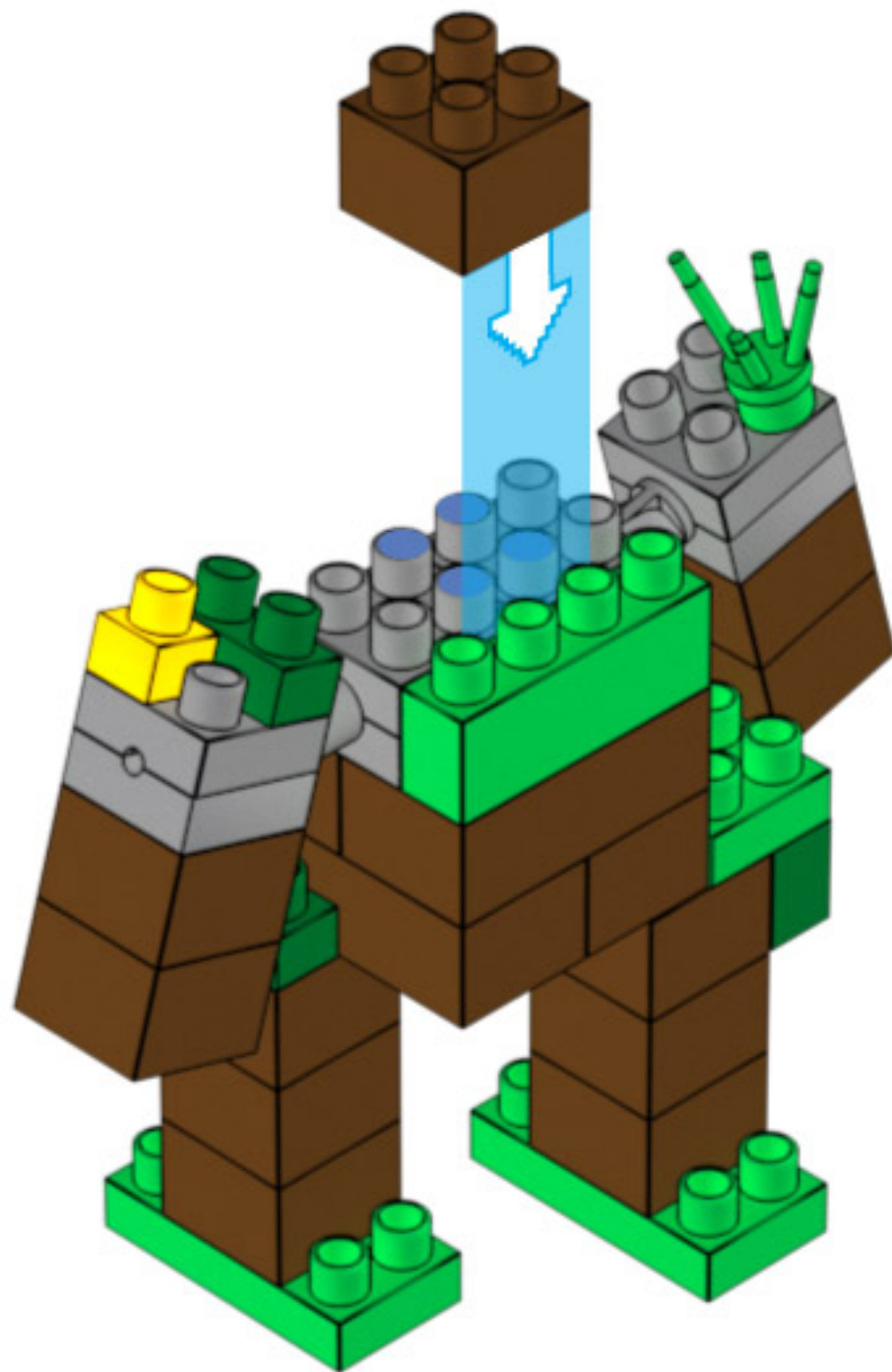

12

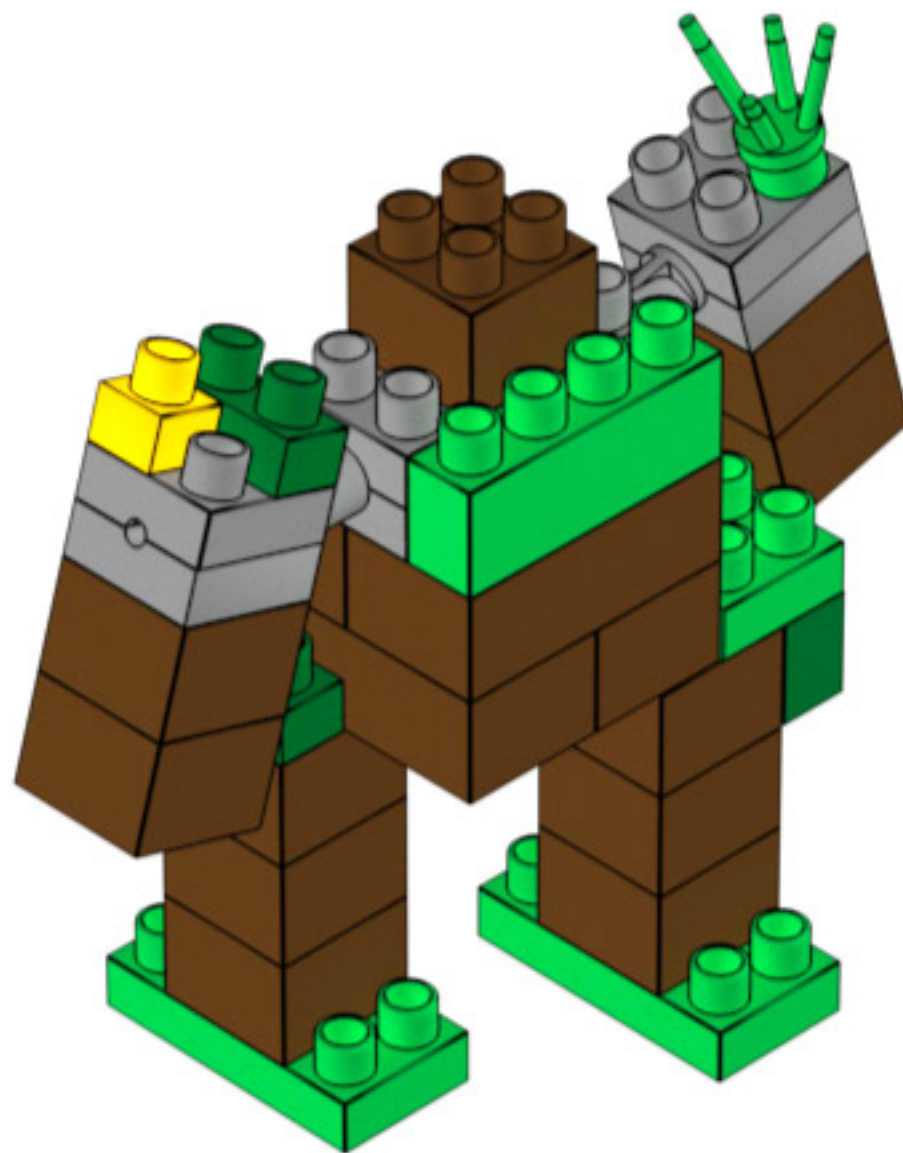

C

13

x3



x1

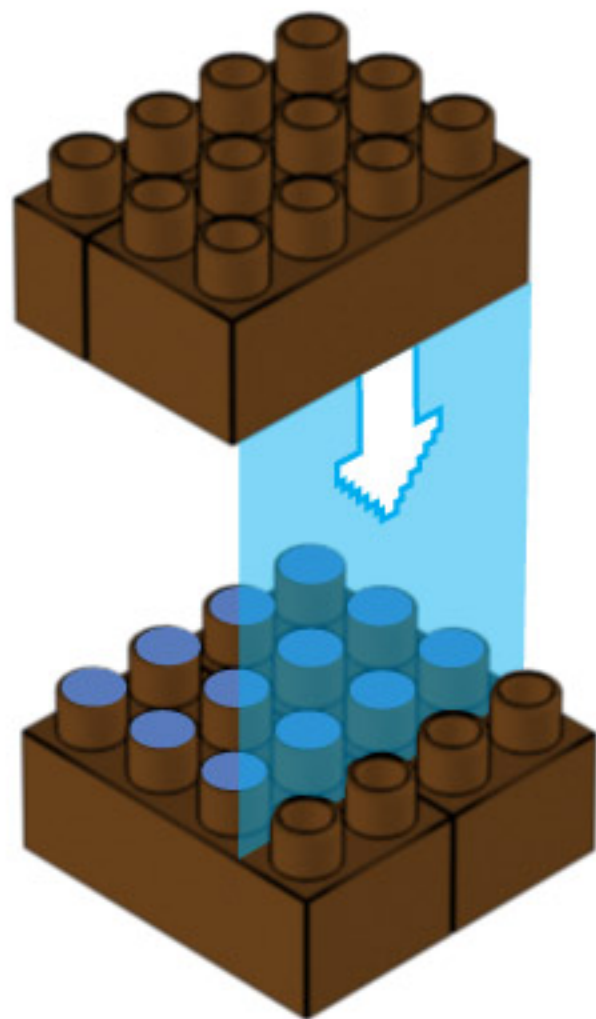

14

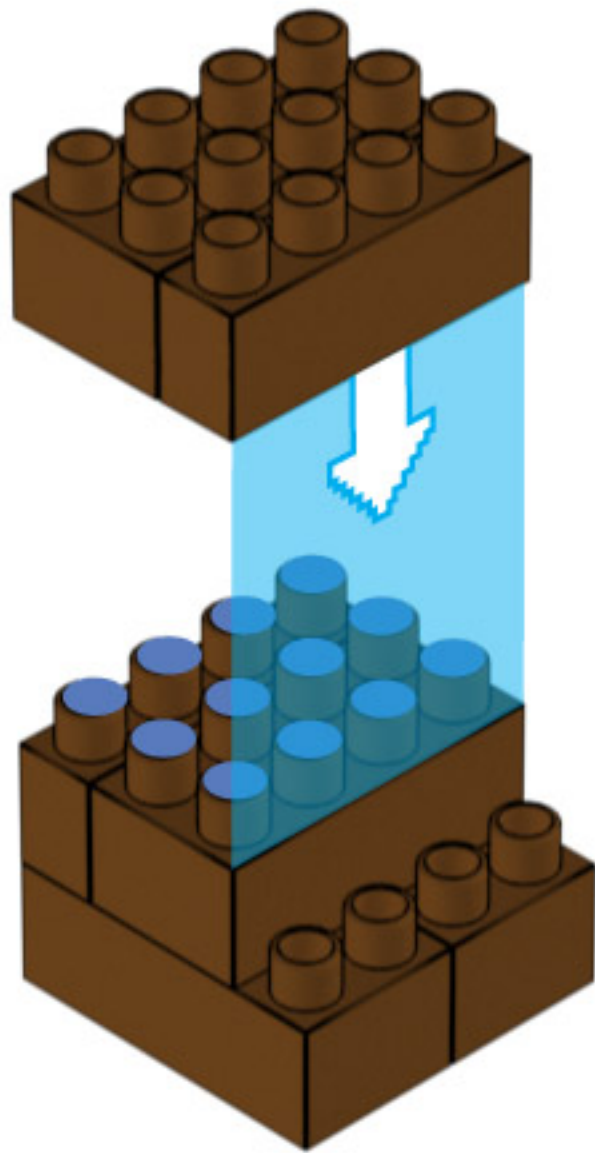
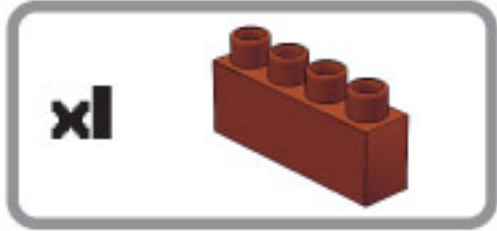
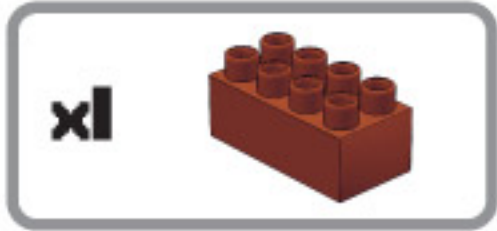

15

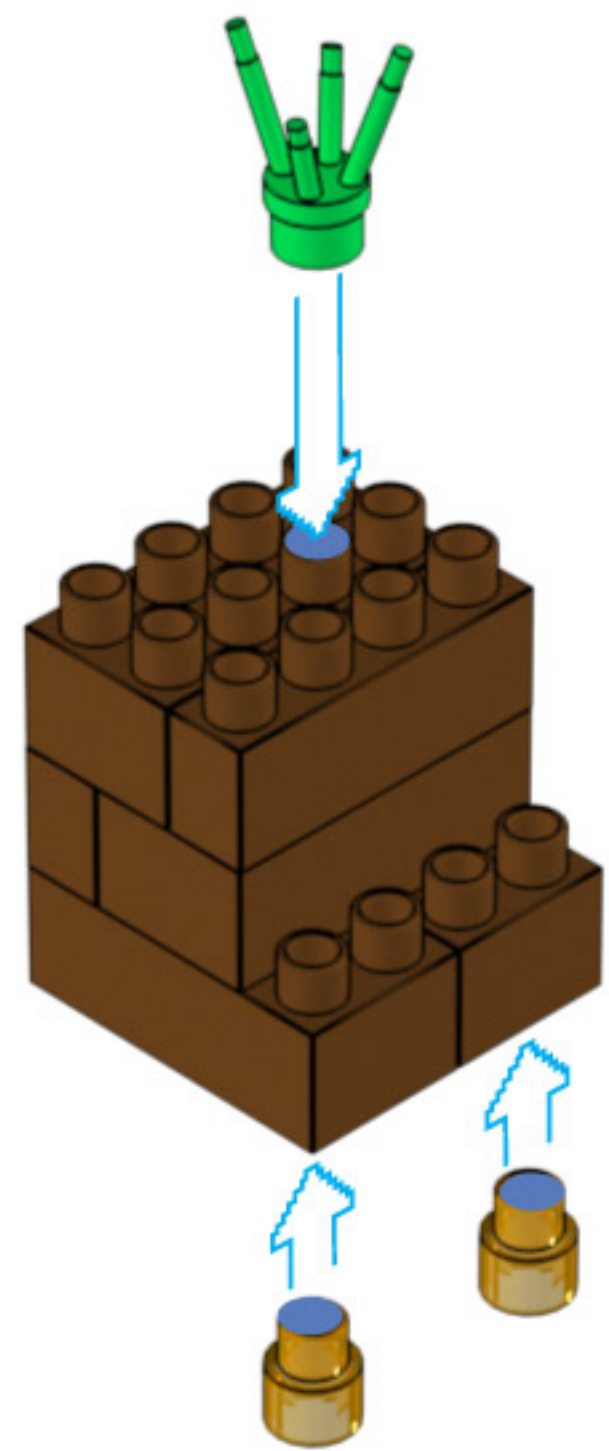

16

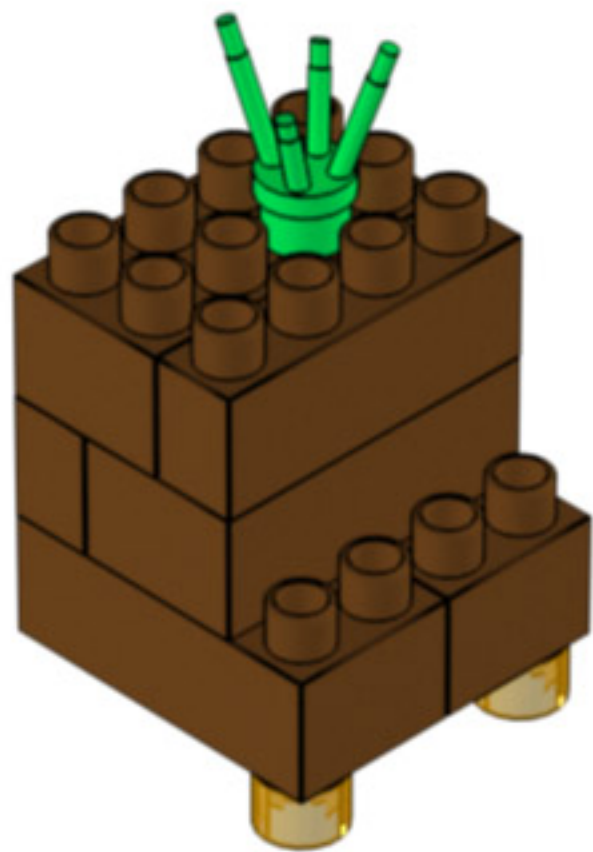

D

17

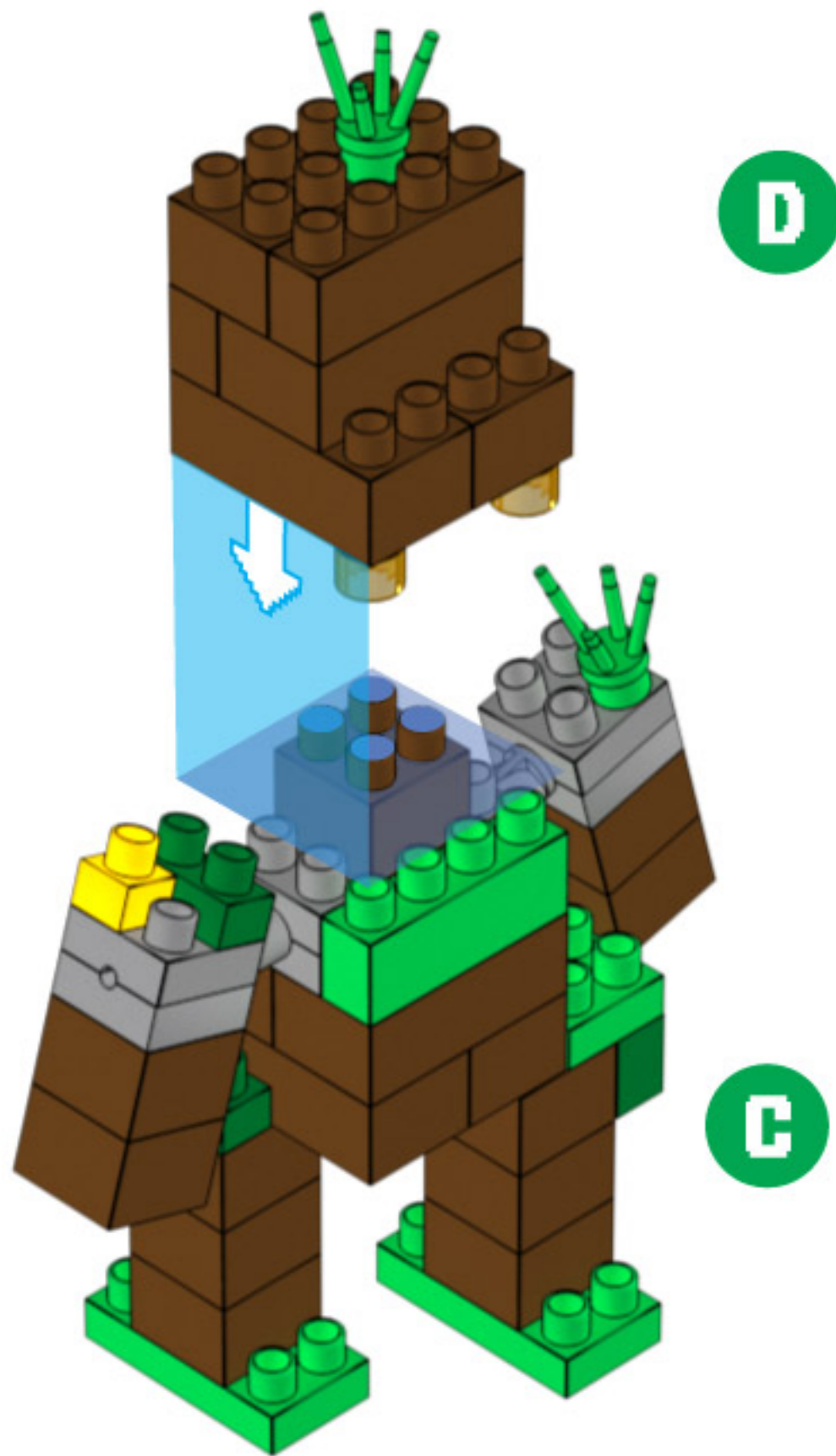

18

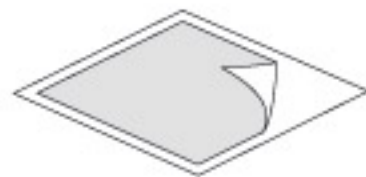

**PEGADO DE
STICKERS**

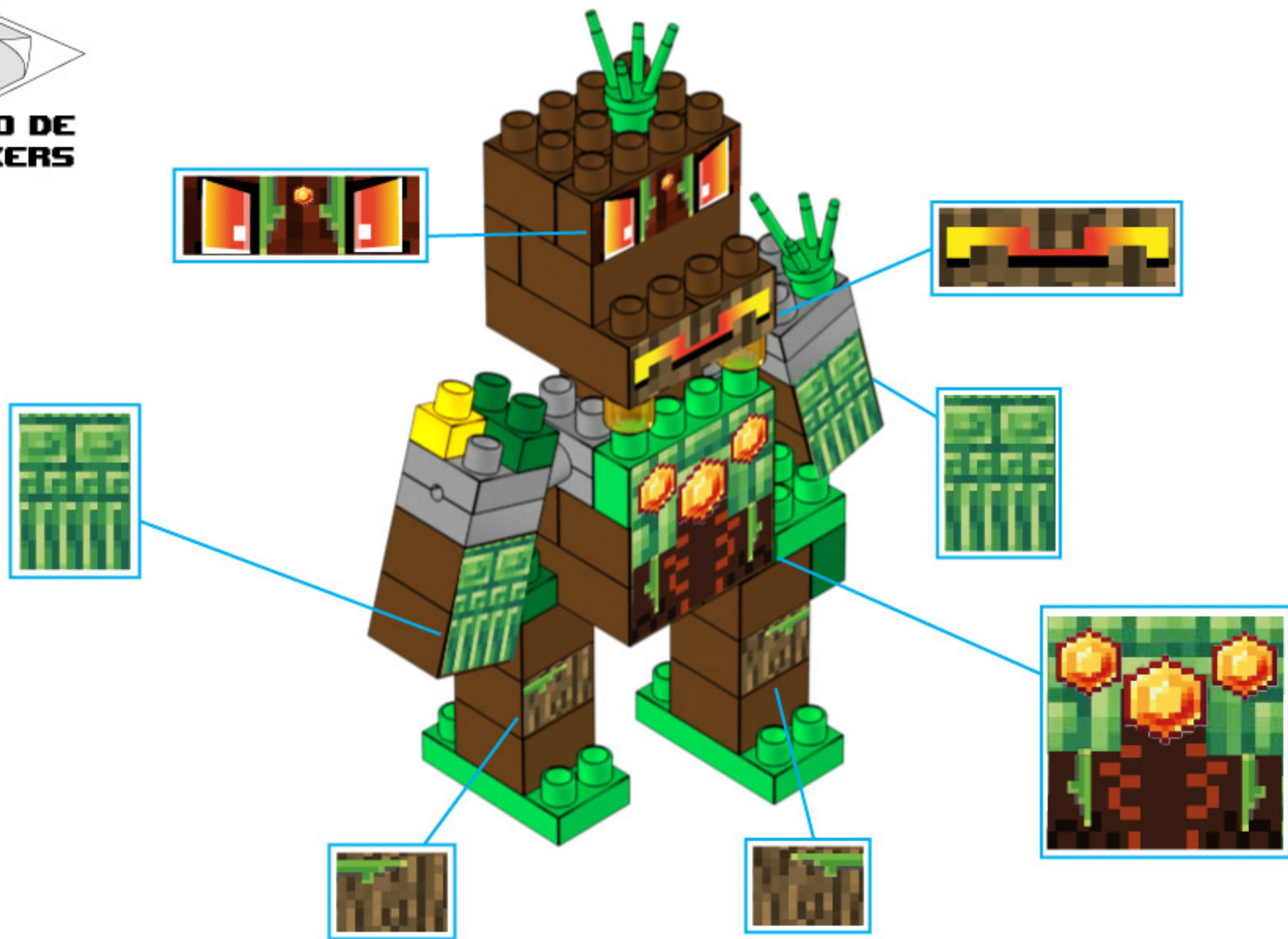

19 **MODELO TERMINADO**



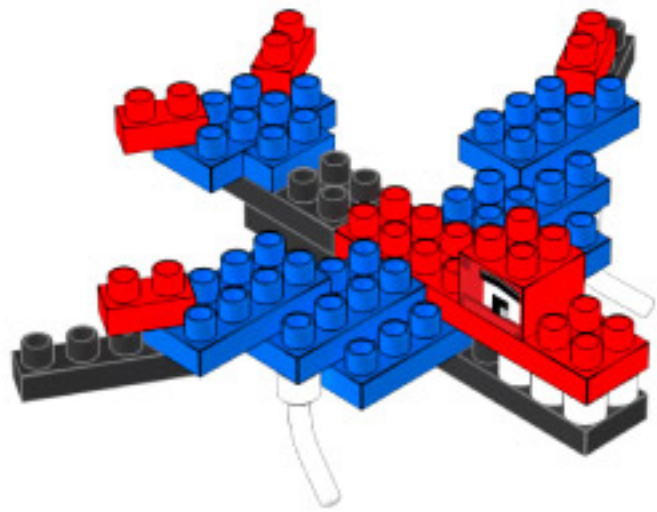

BUITRE

I

x2



x1

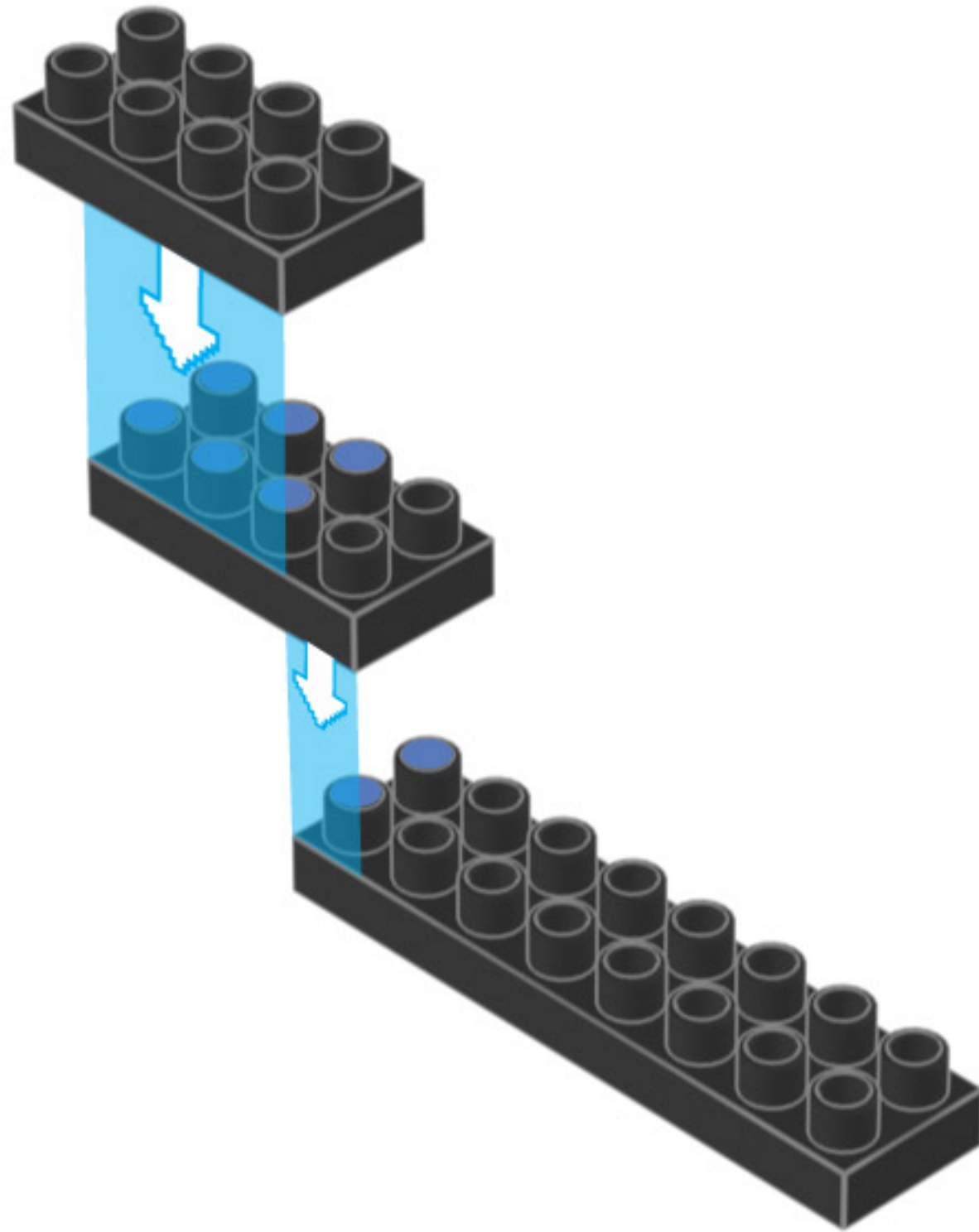

2

x1

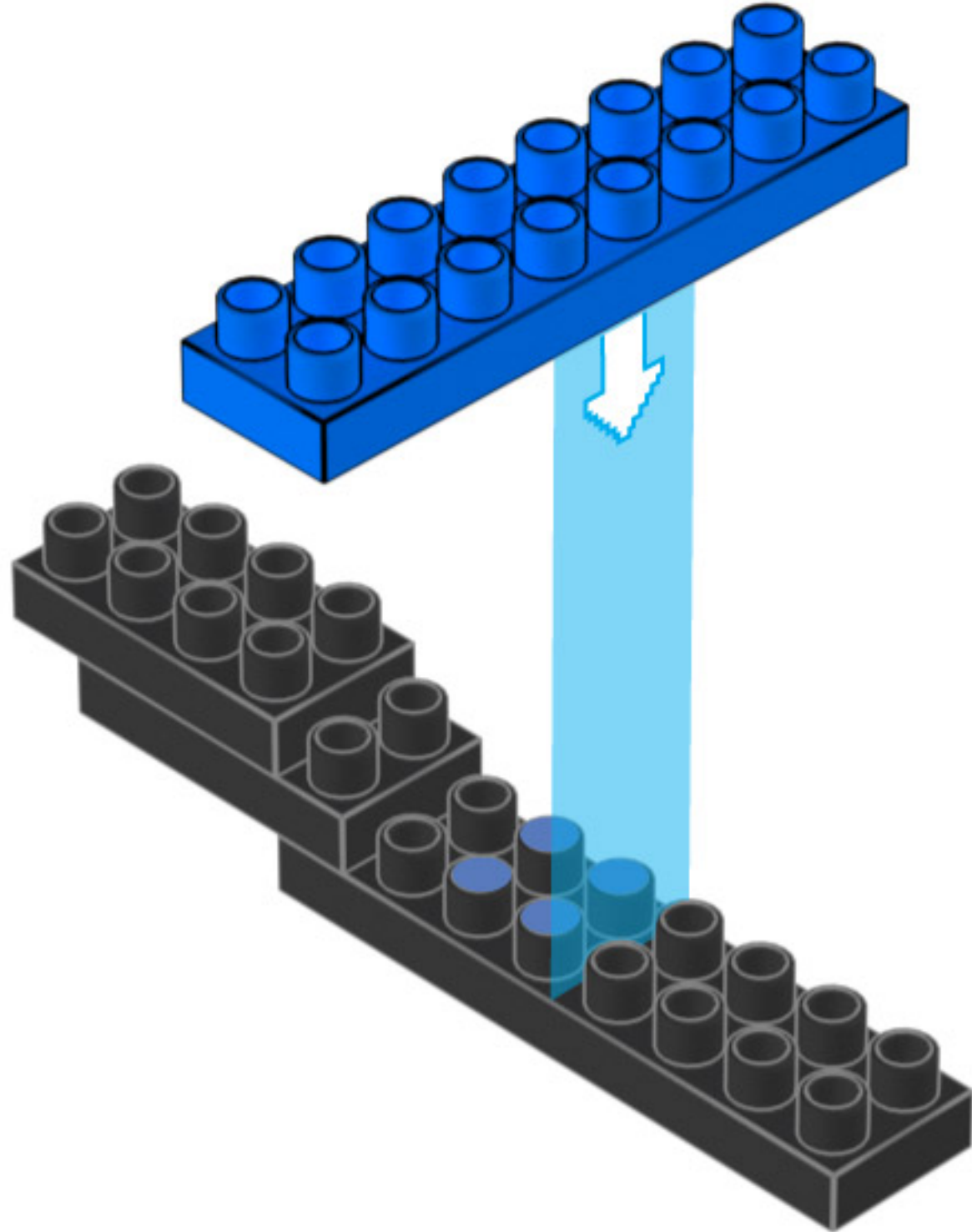

3

x6

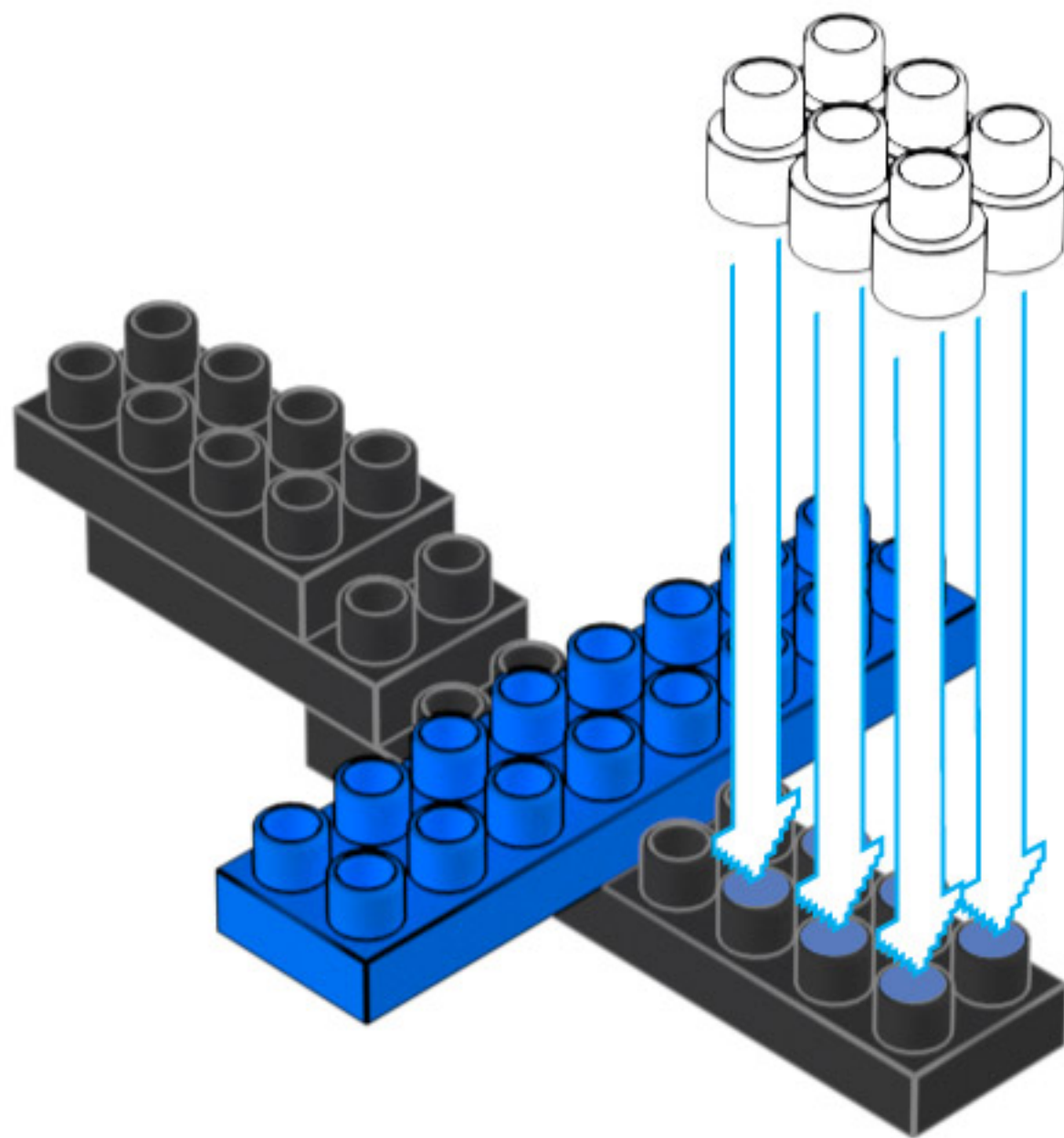

5

x1

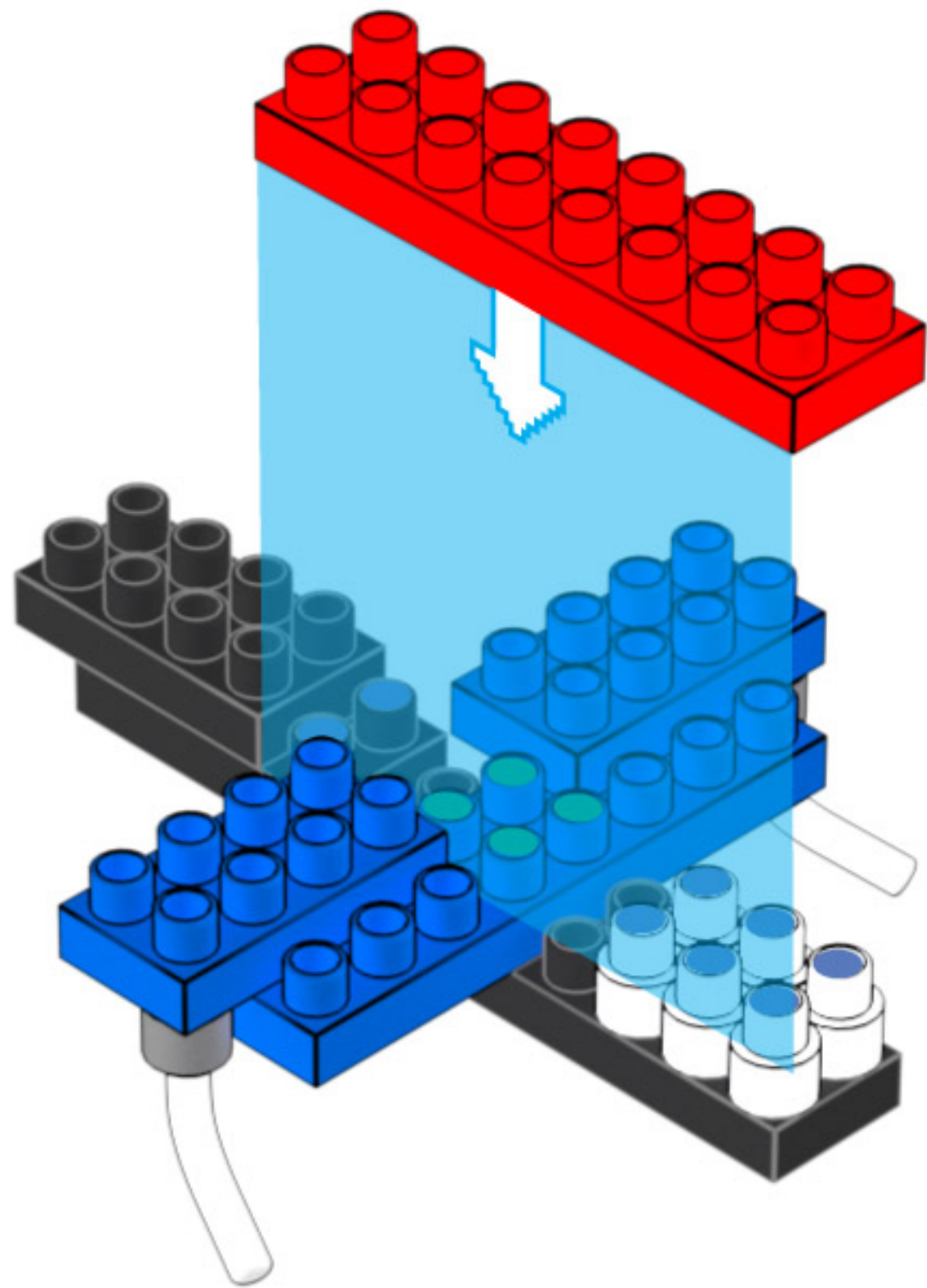

6

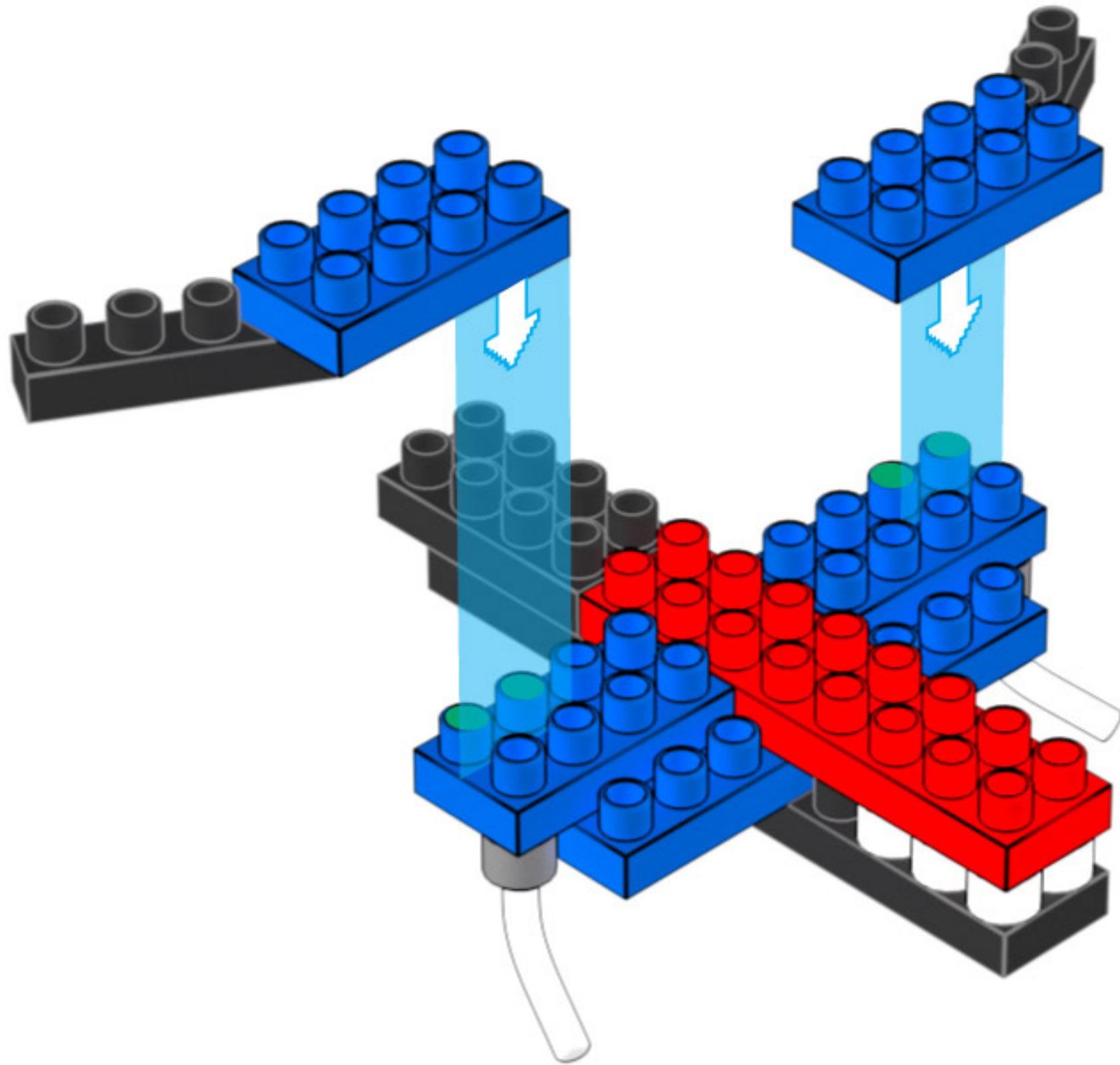
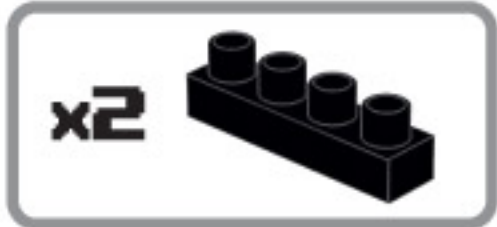

7

x1

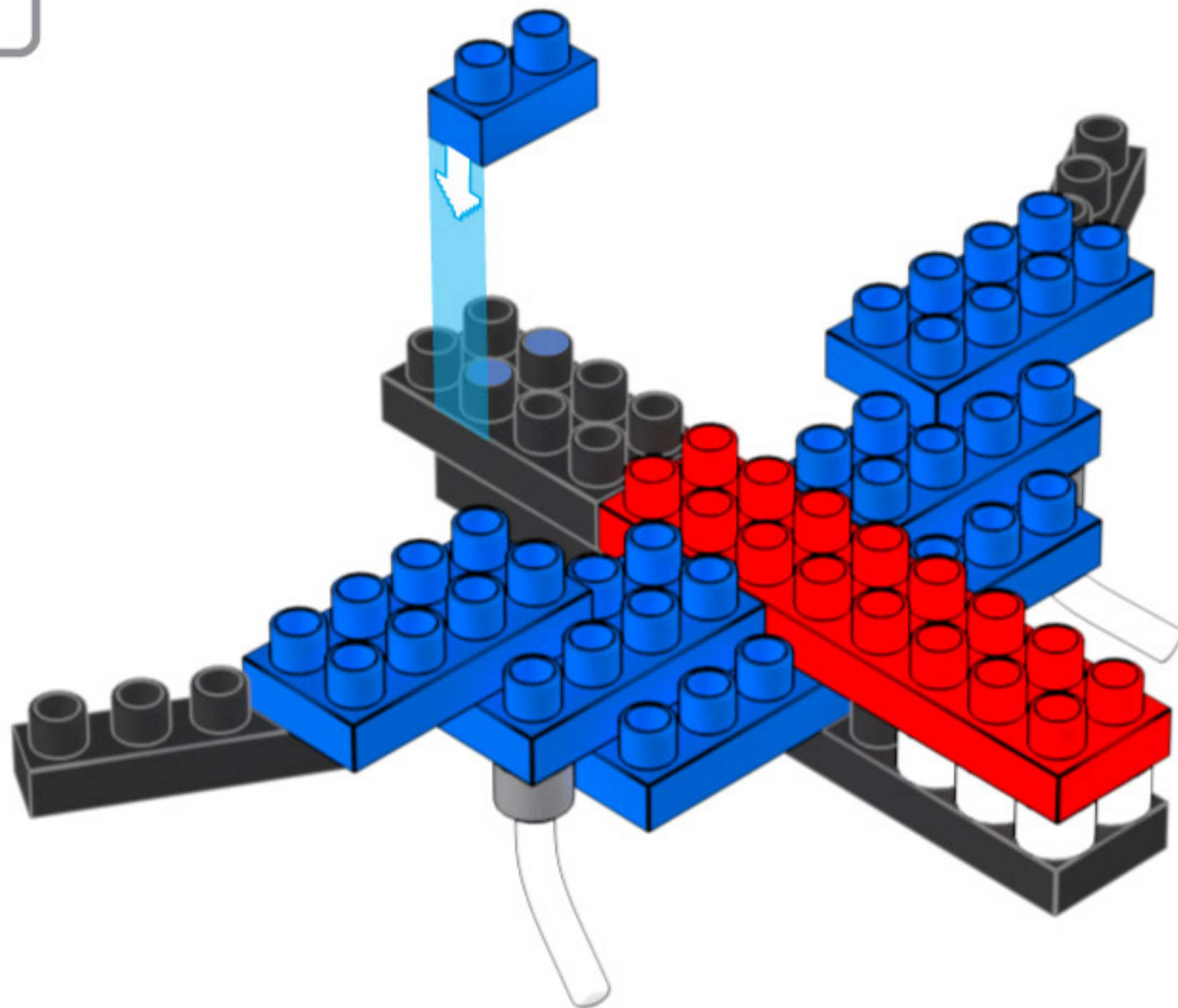

8

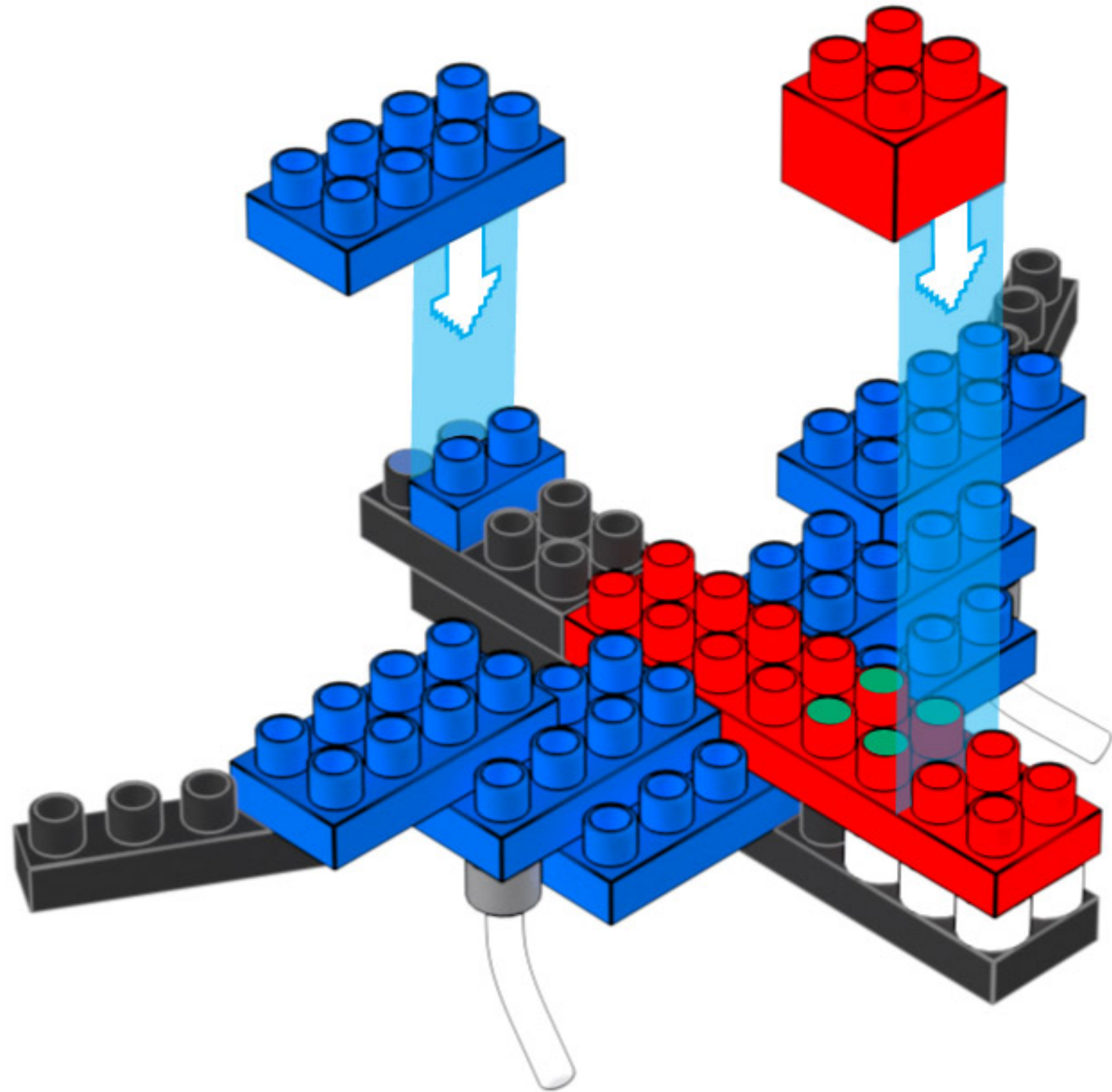
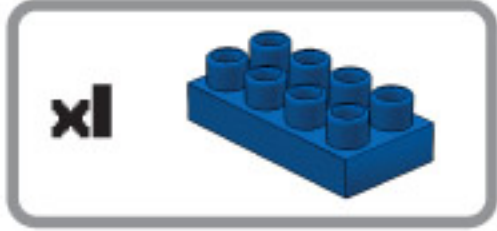

9

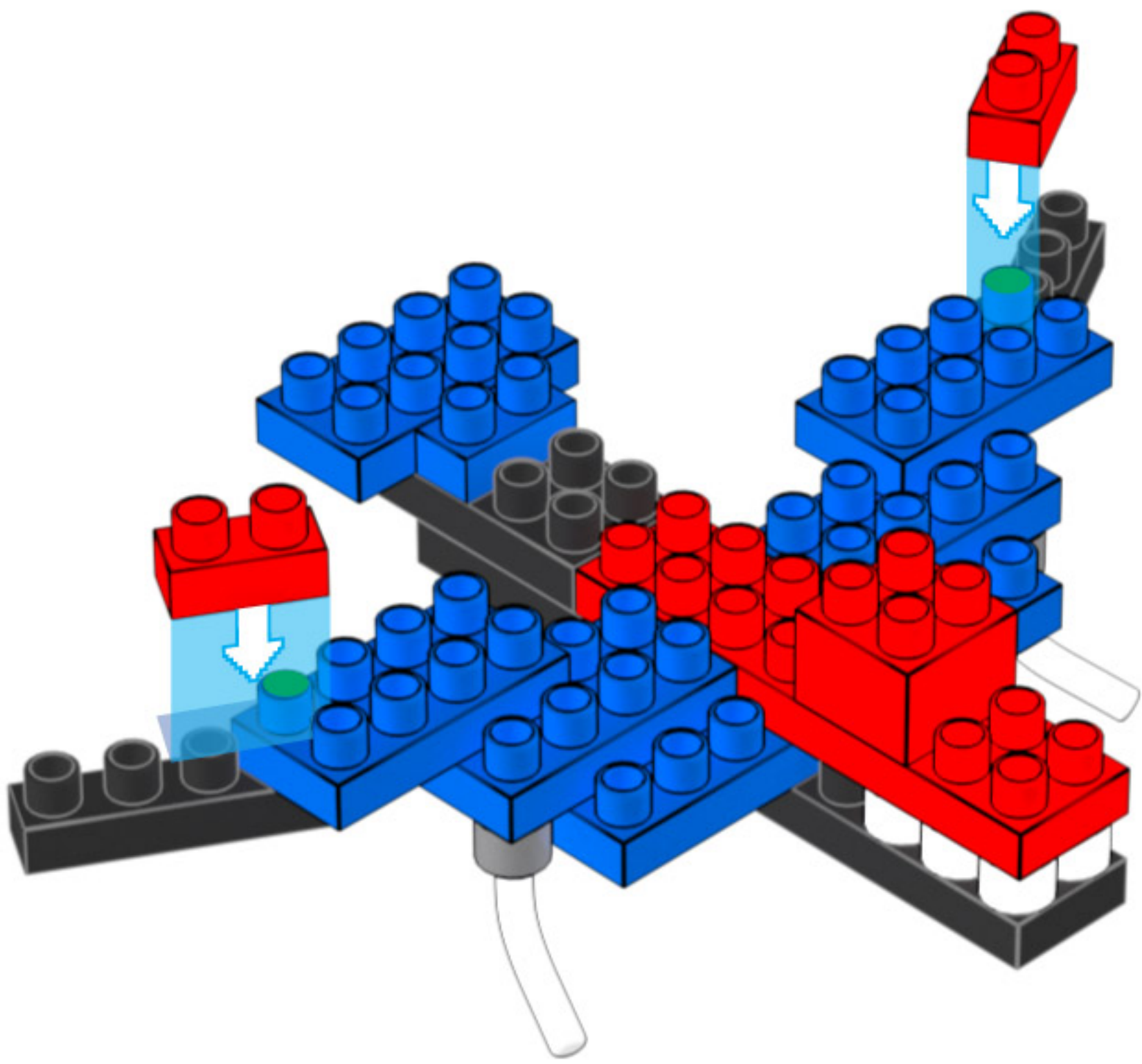
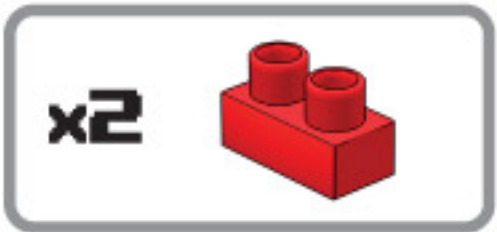

10

x2

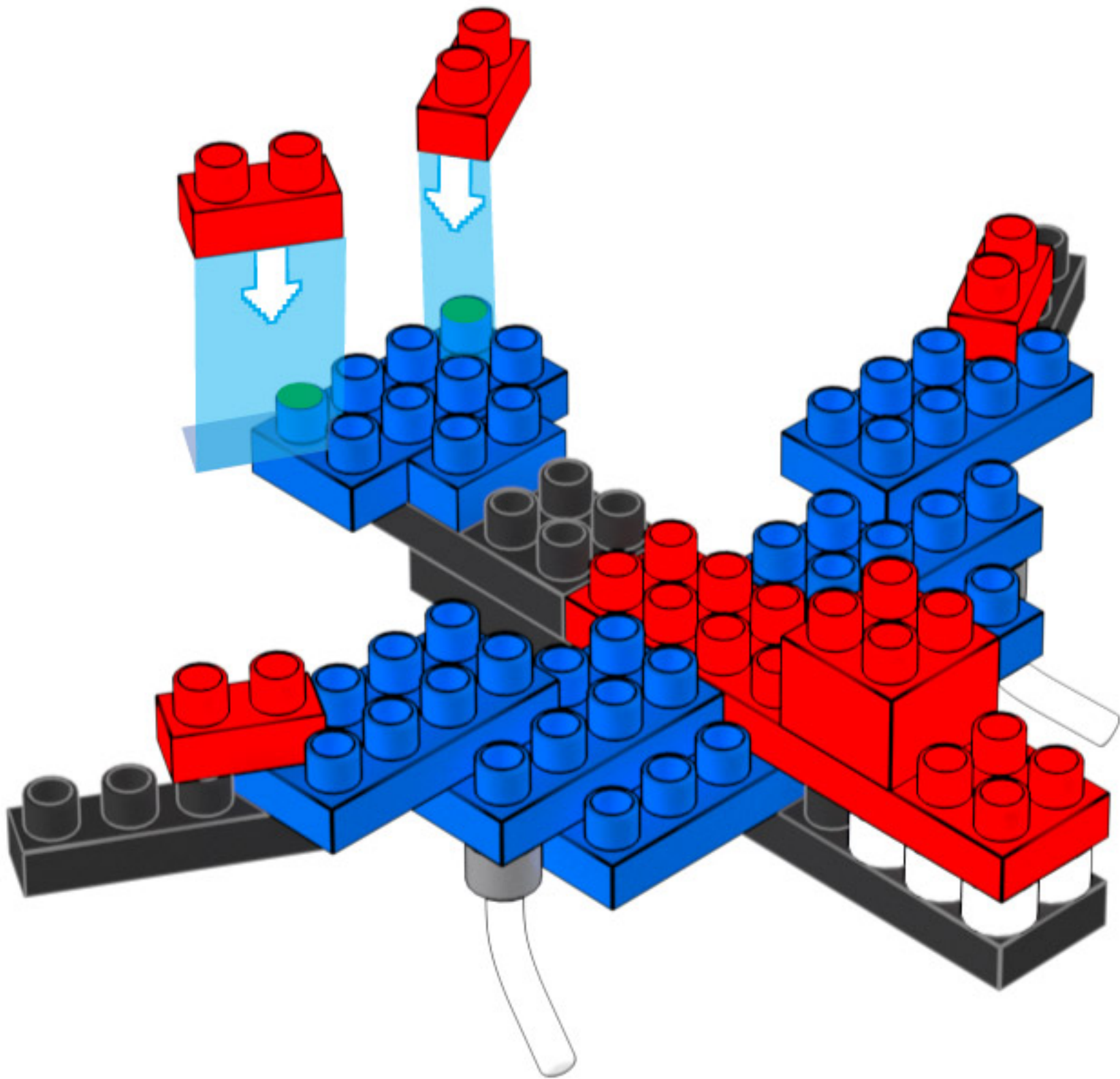

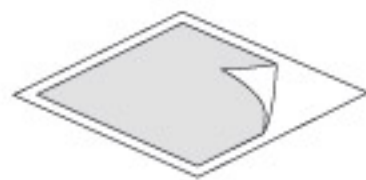

**PEGADO DE
STICKERS**

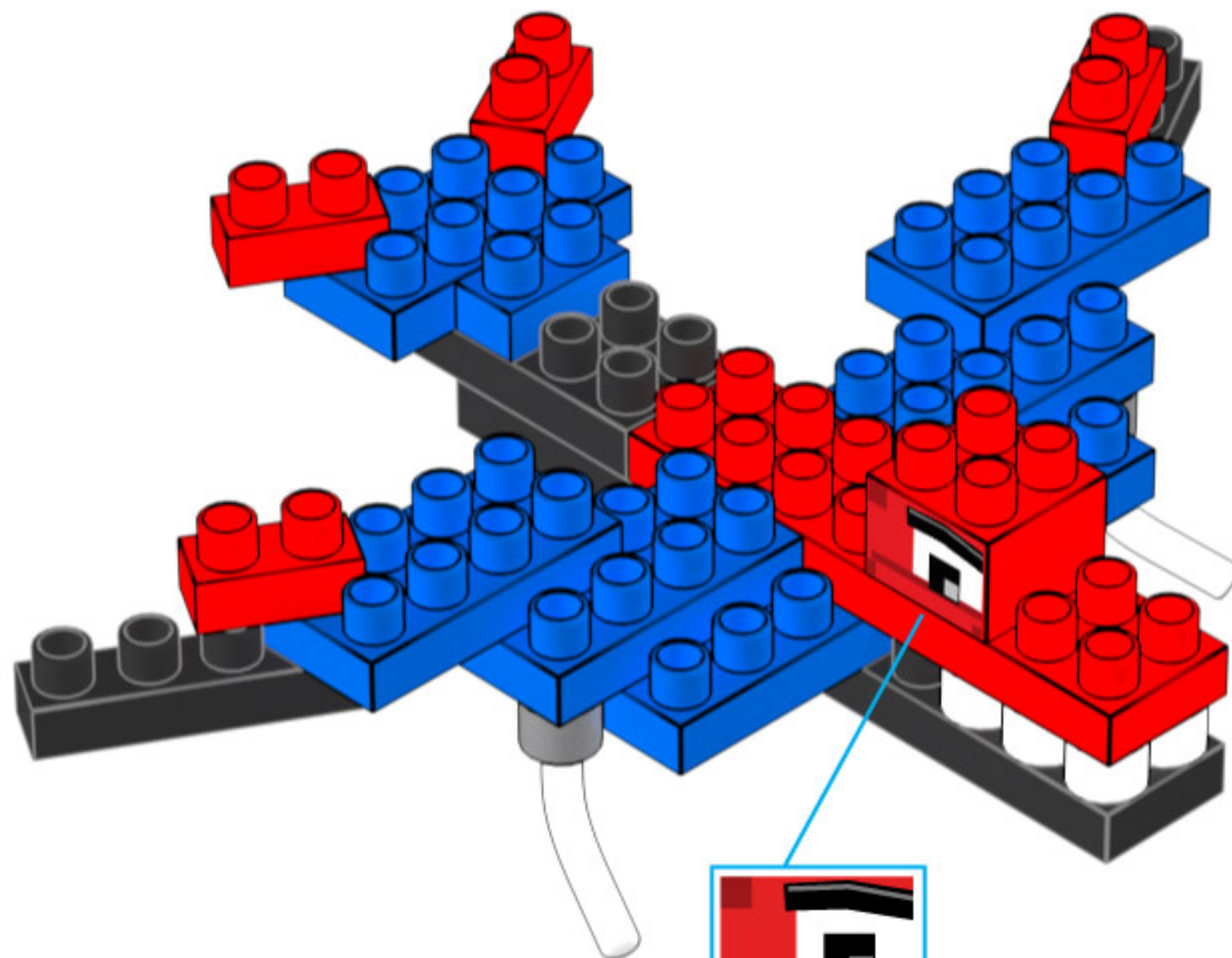

**PEGAR DE
AMBOS LADOS**

12

MODELO TERMINADO

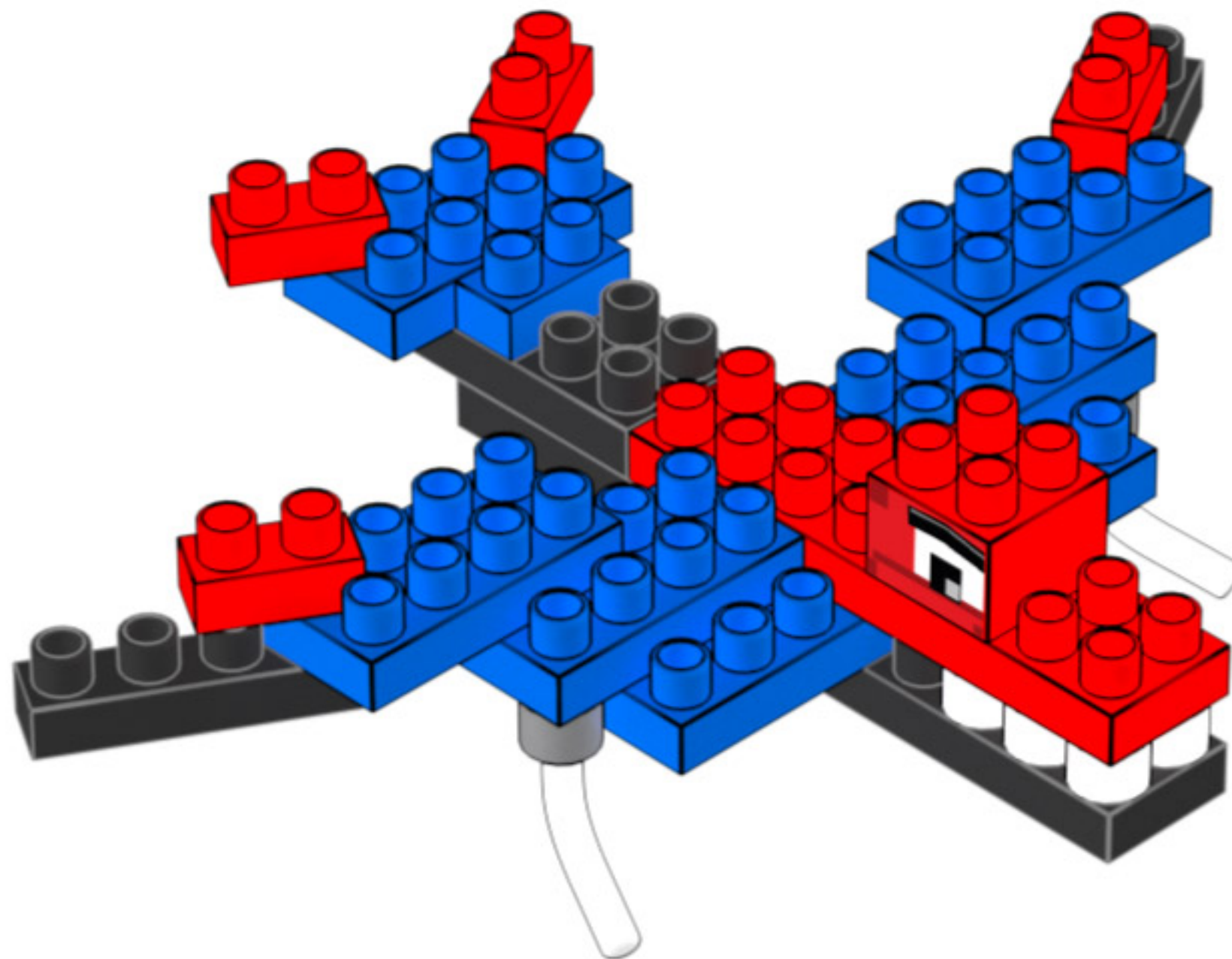



REFUGIO

I

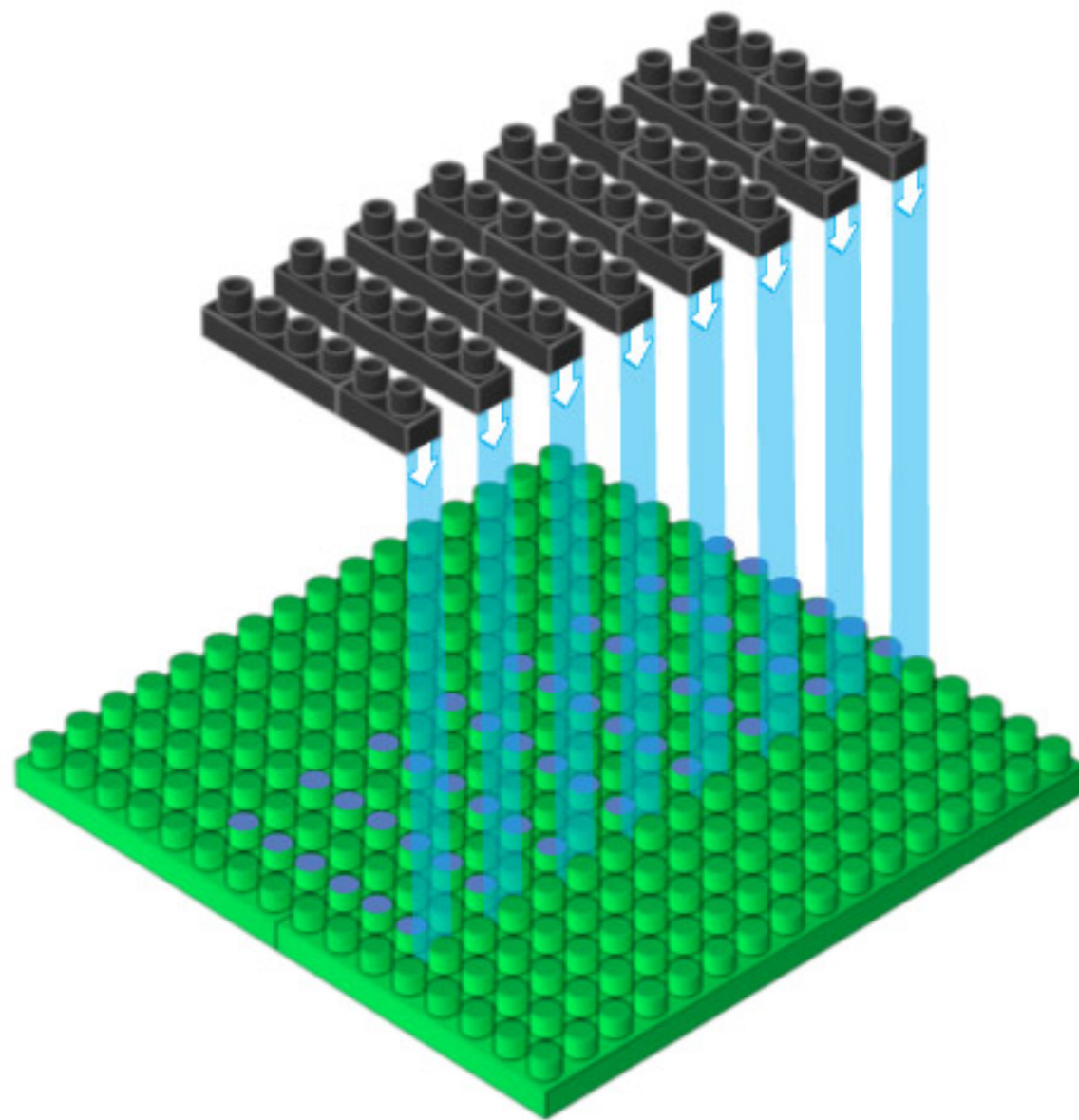
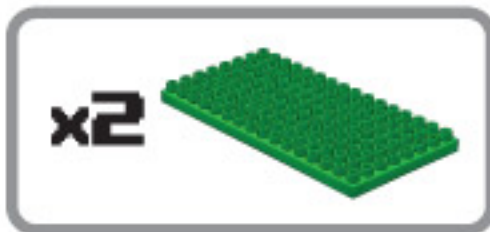
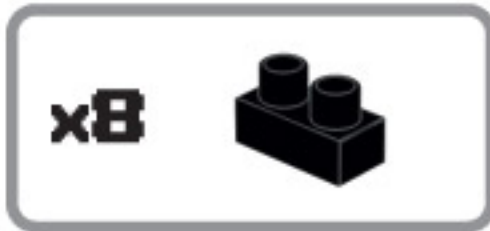
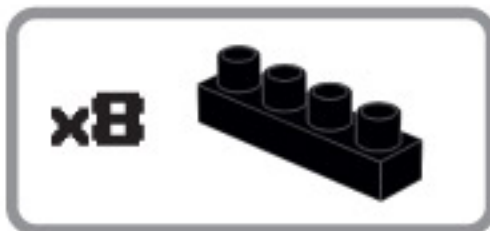

2

x8

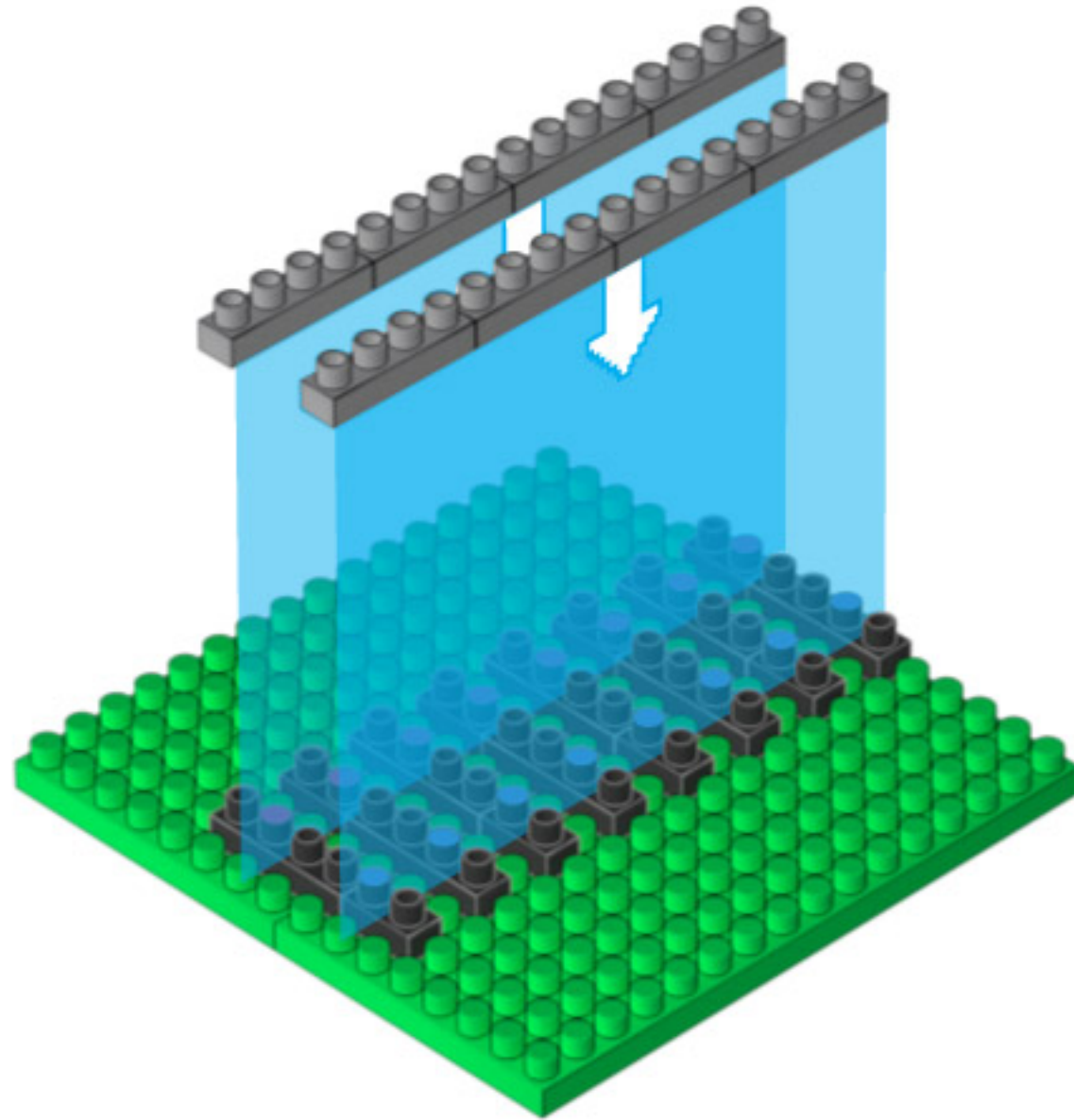

3

x4

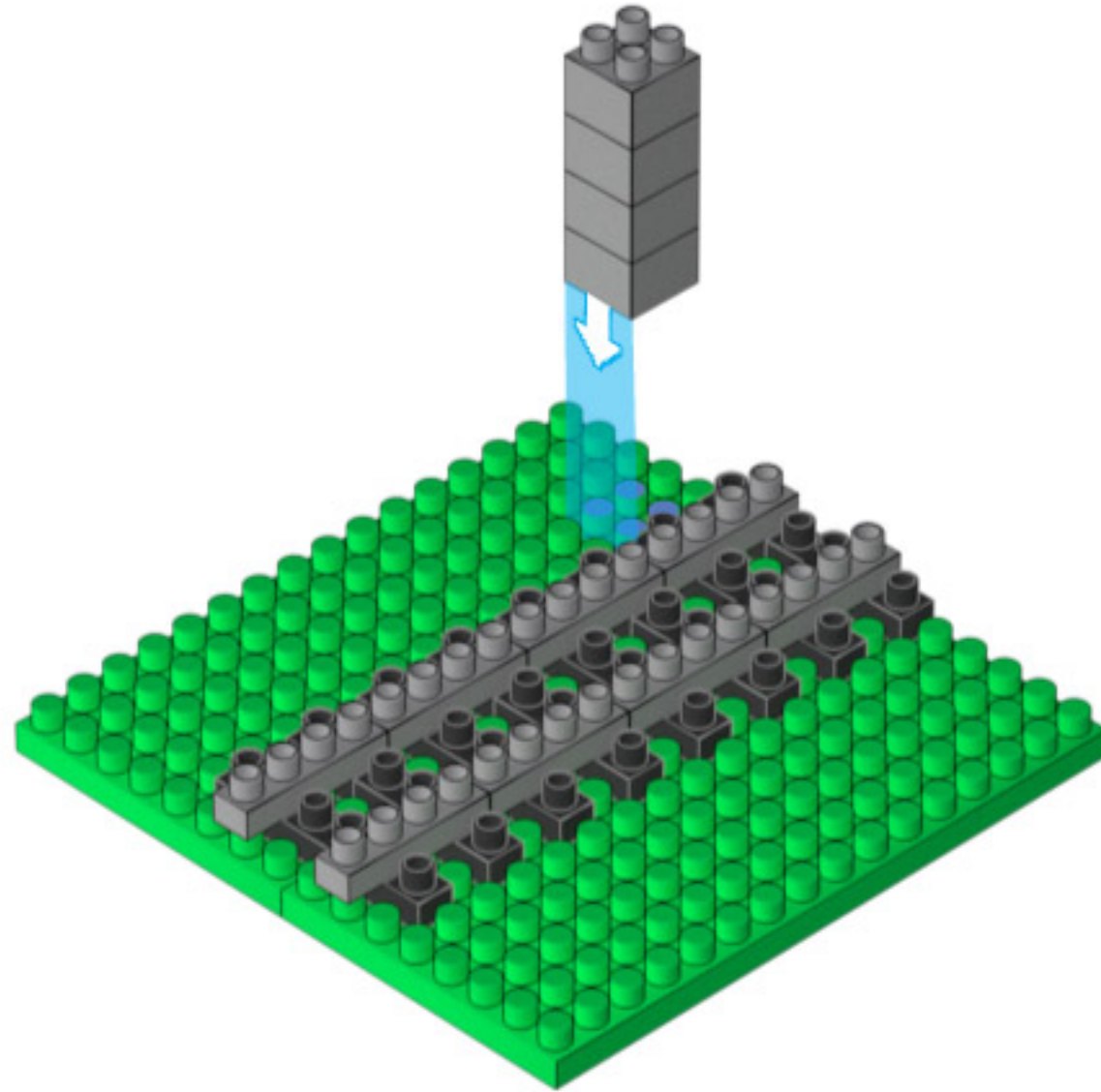

4

x4

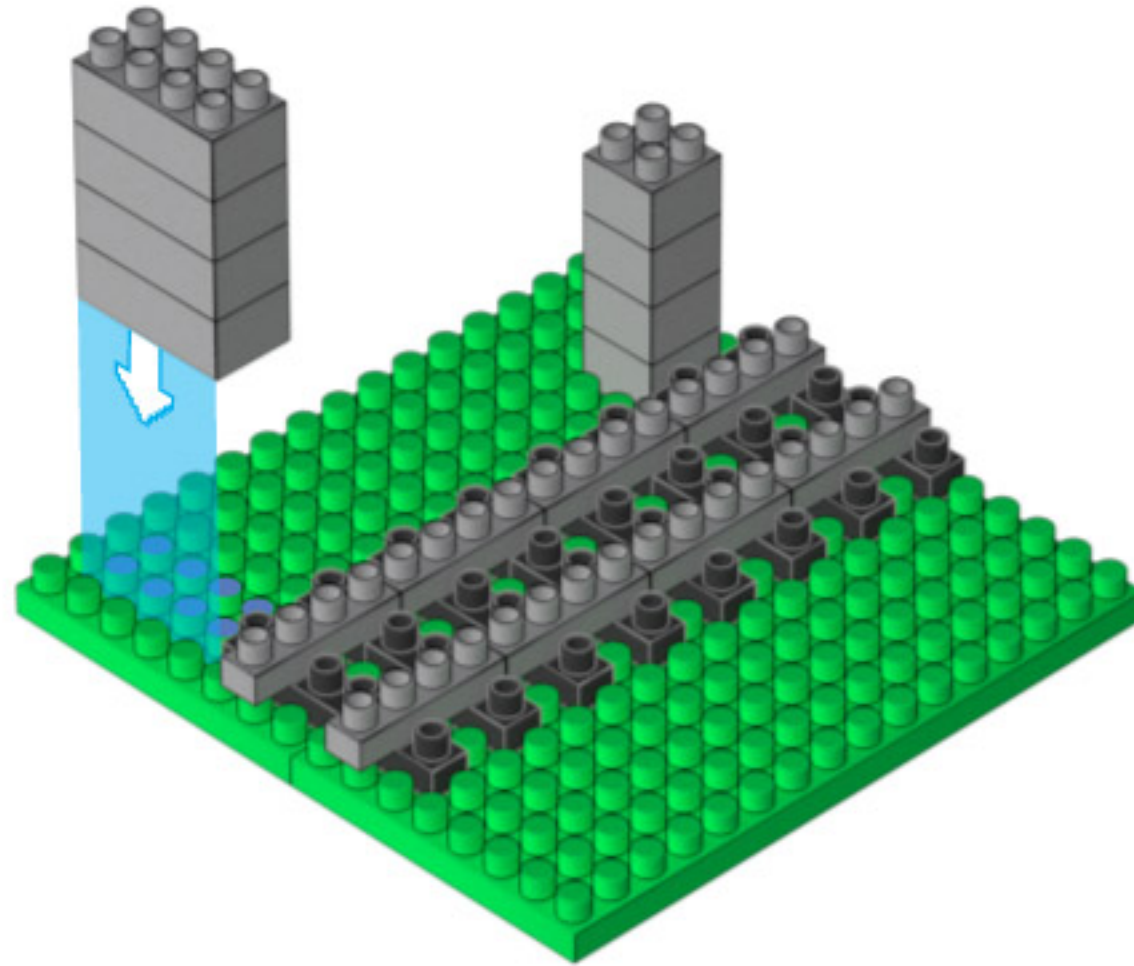

5

x4

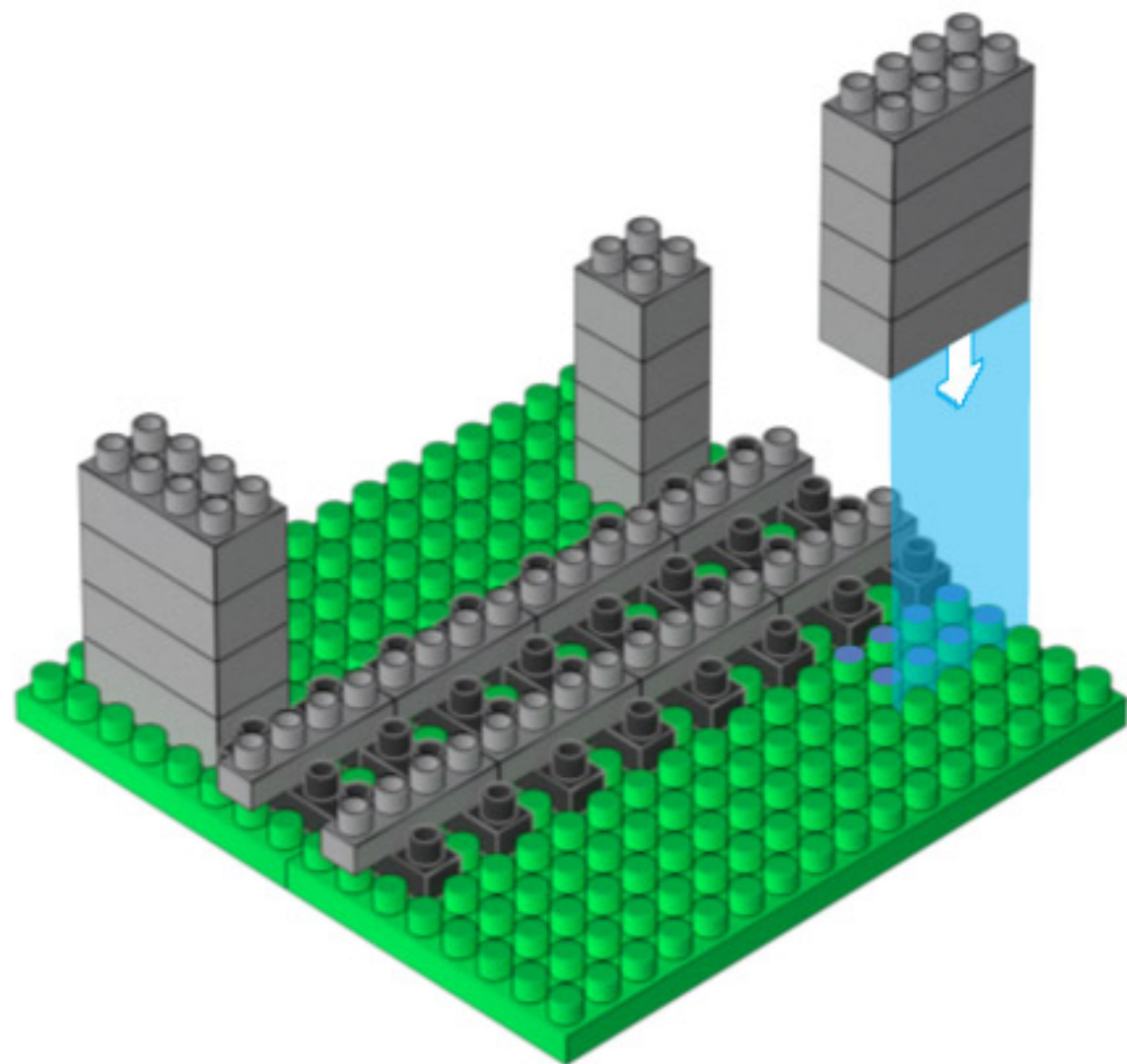

6

x1

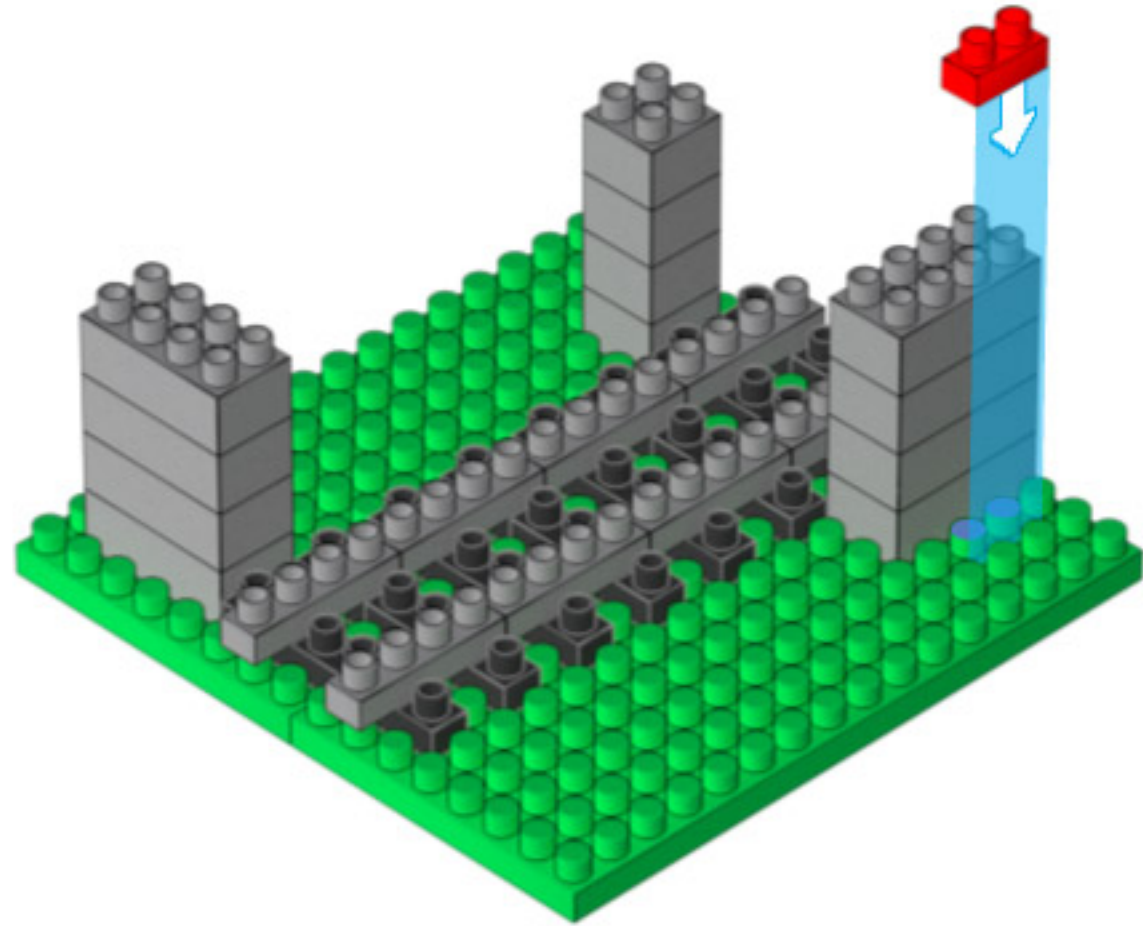
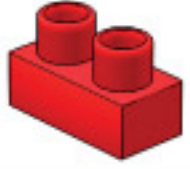

7

x2

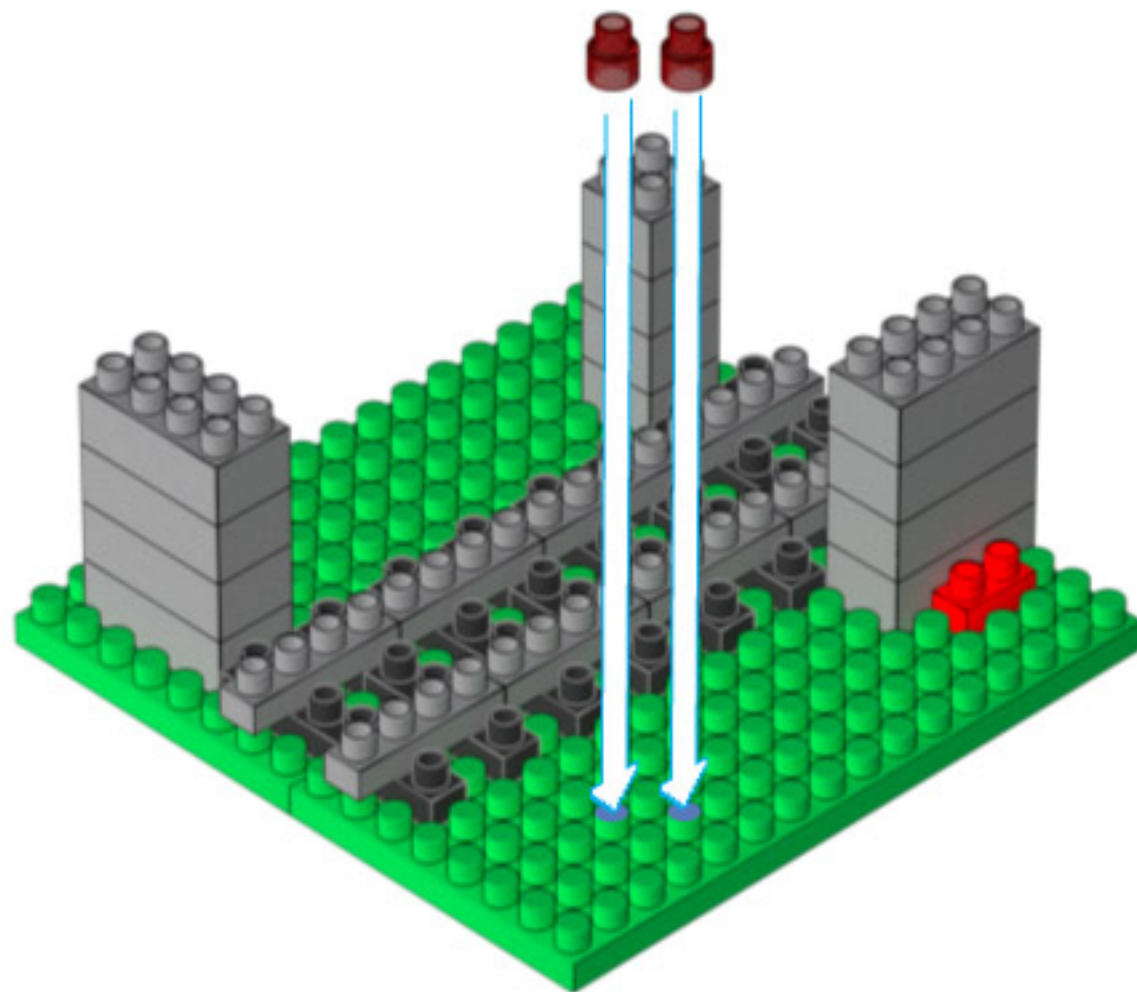

8

x2

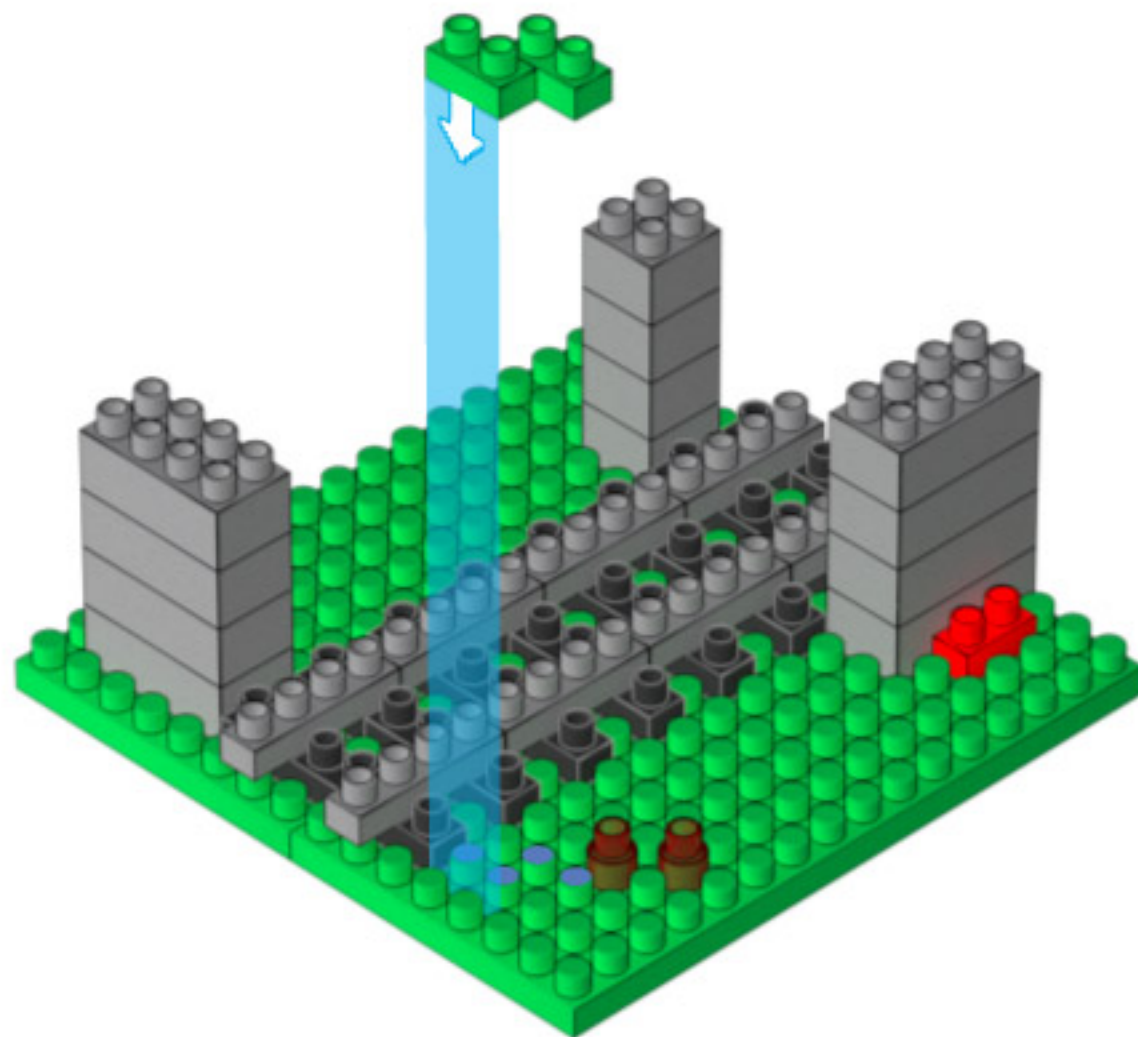
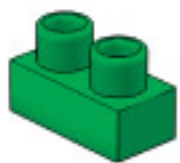

9

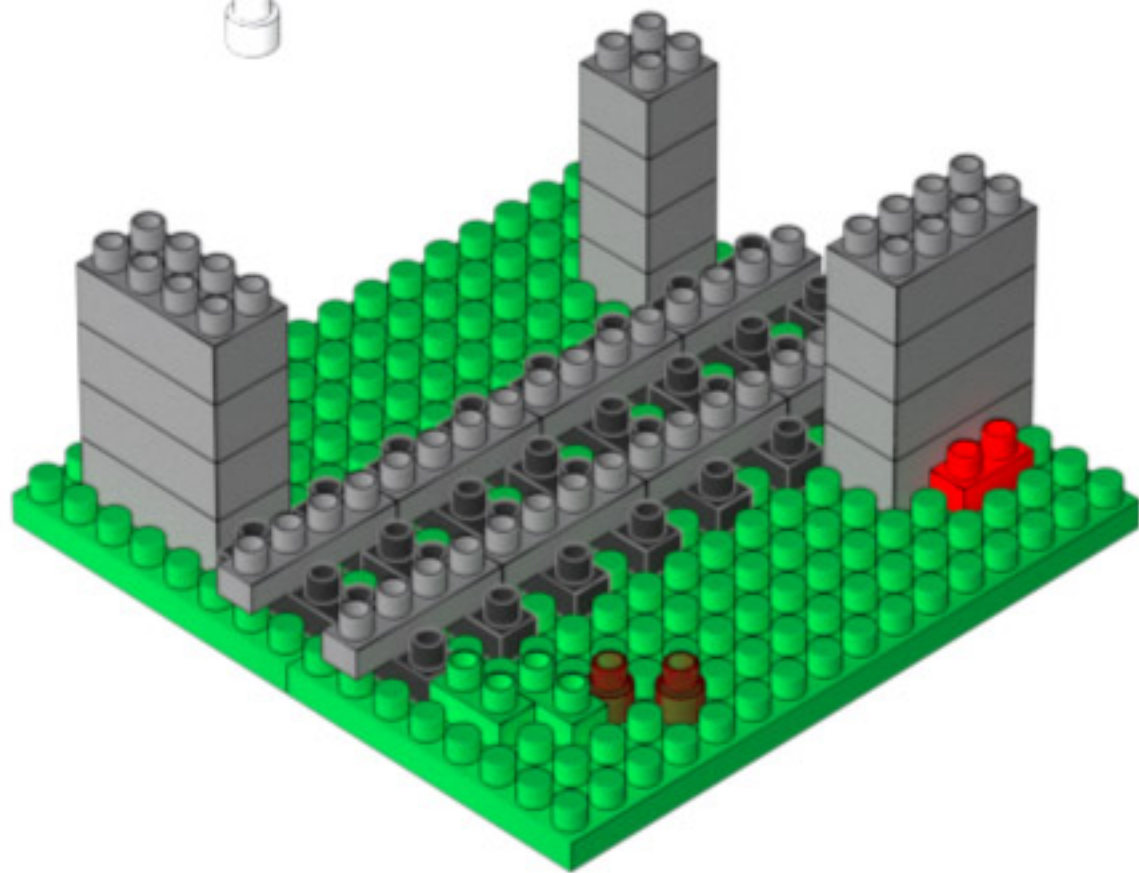
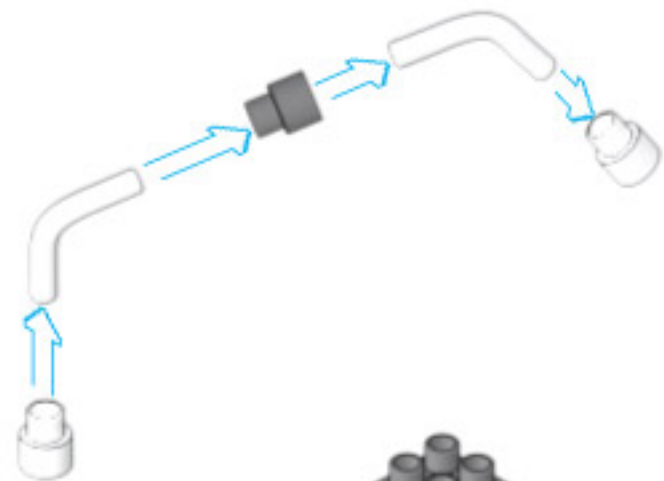
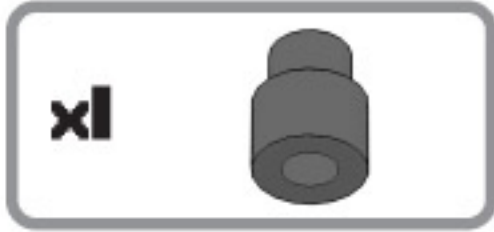

10

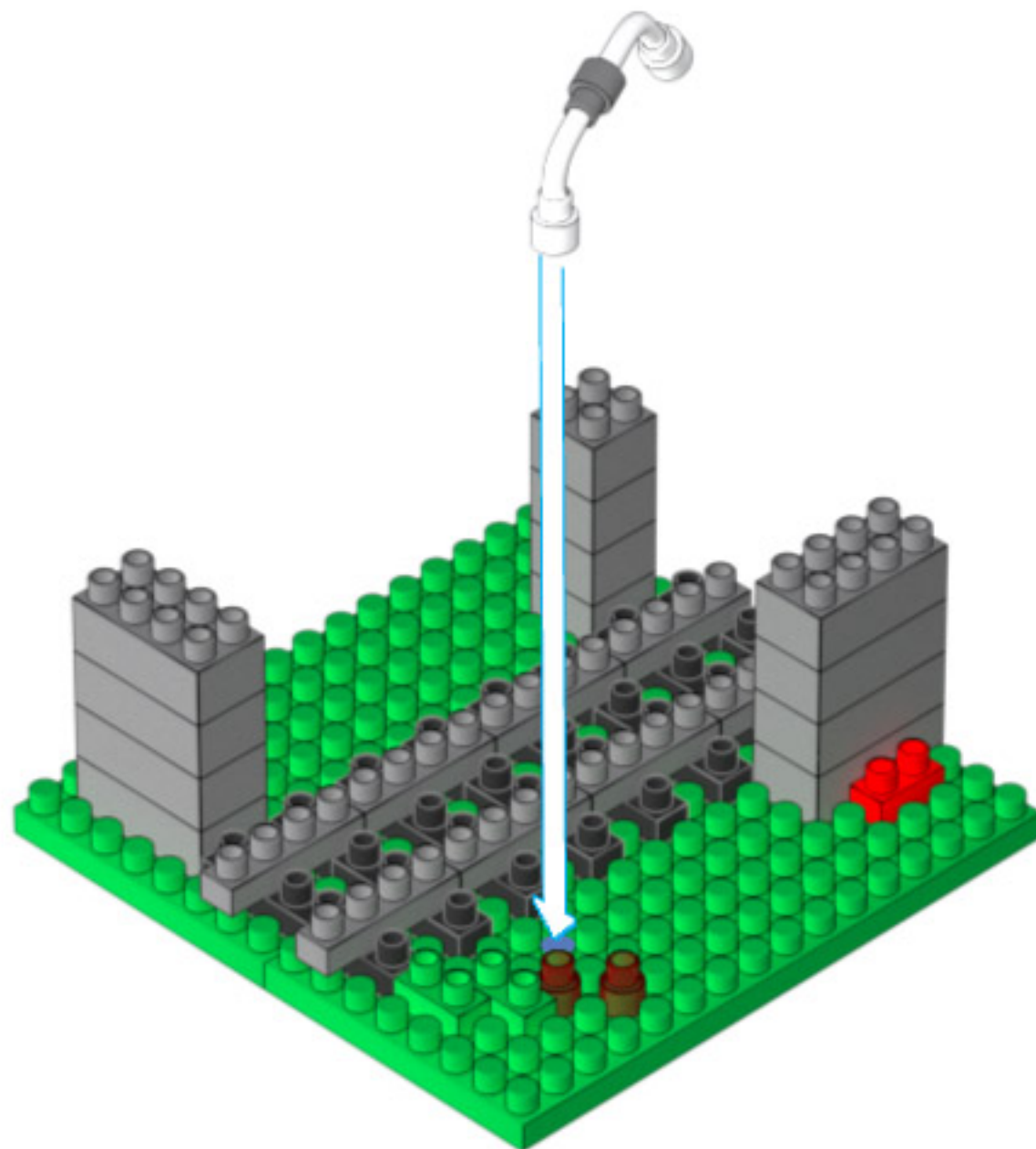

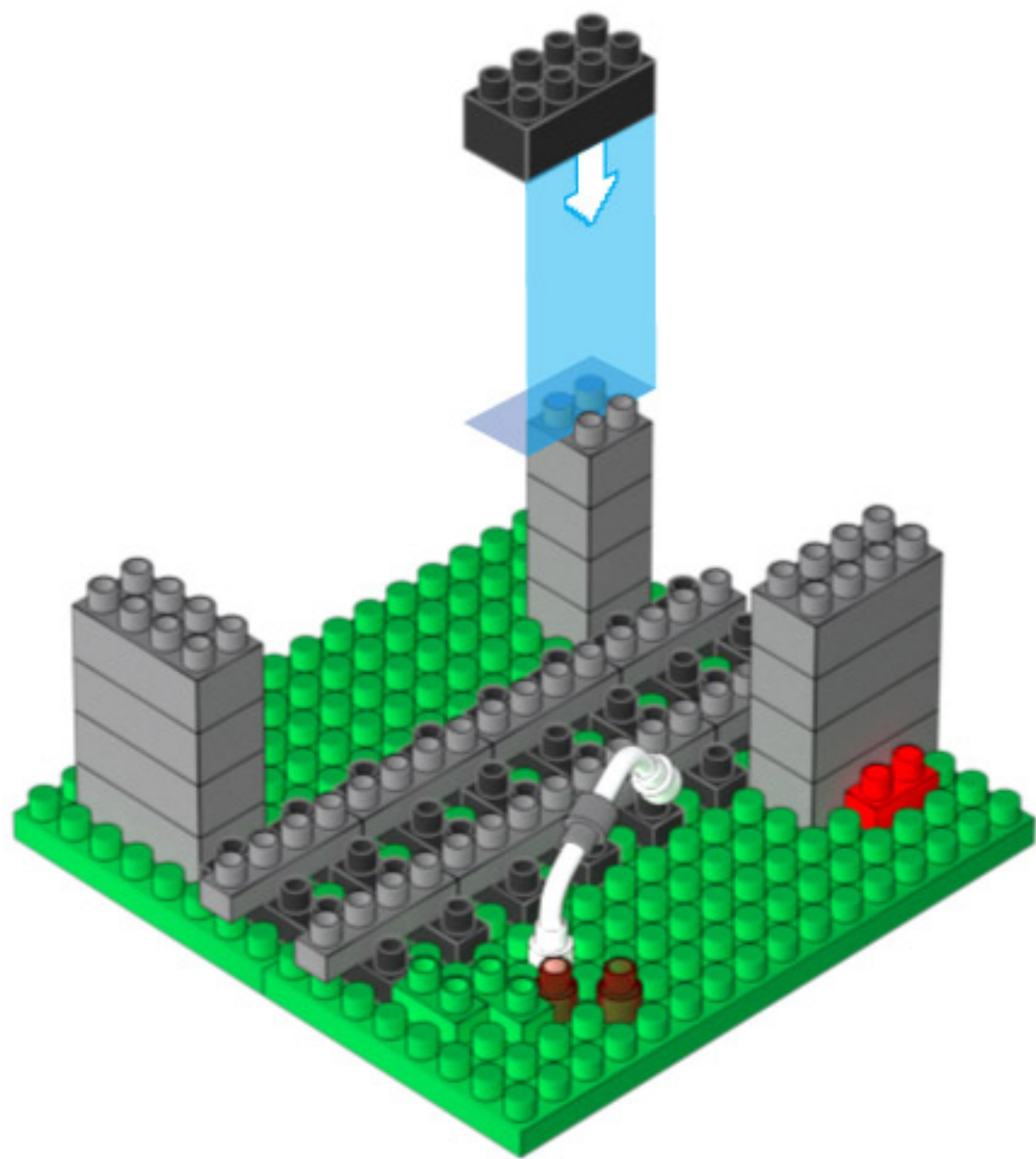
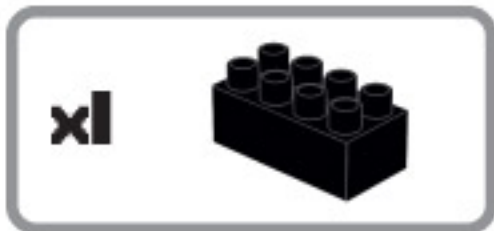

12

x2

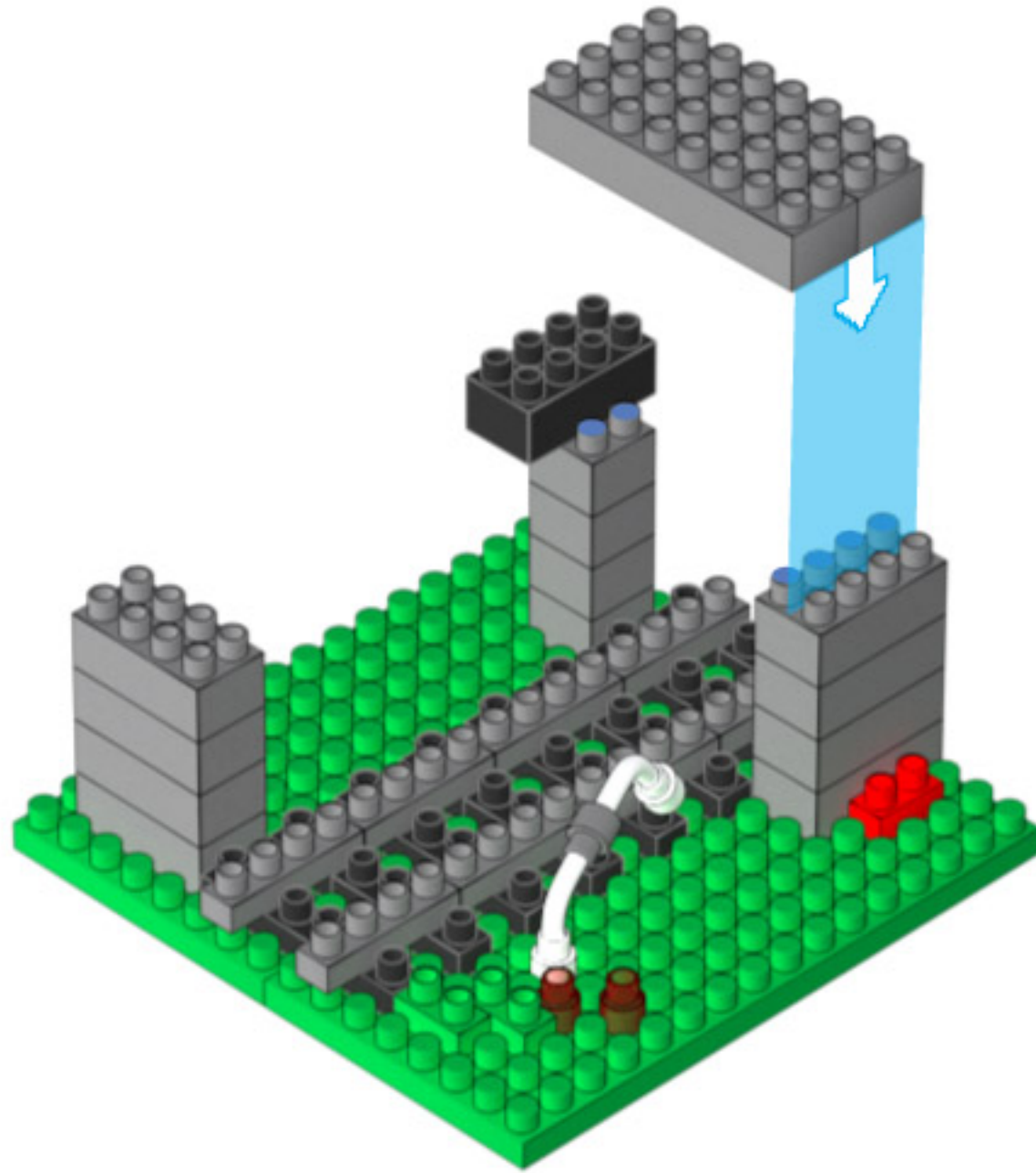

13

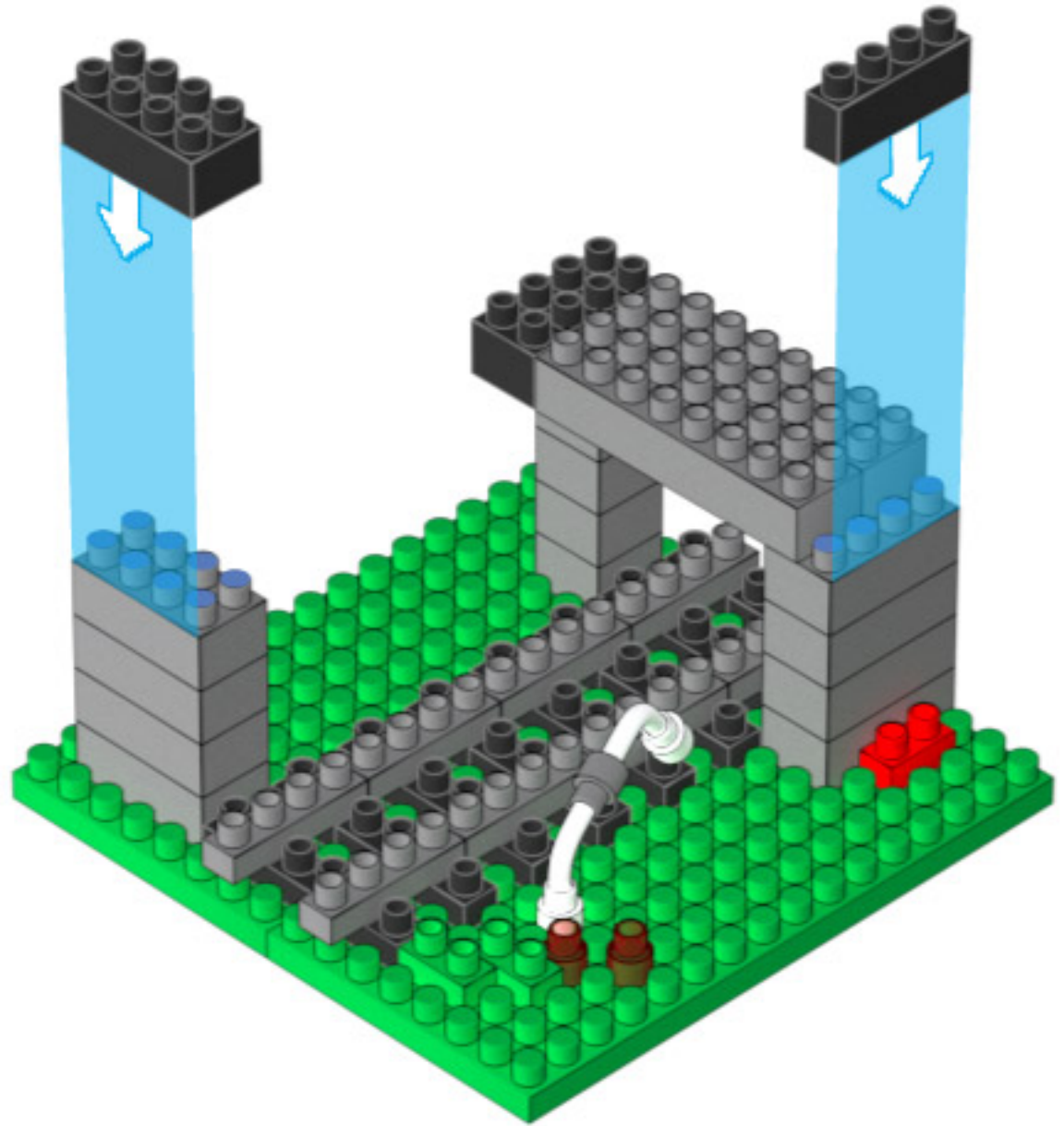
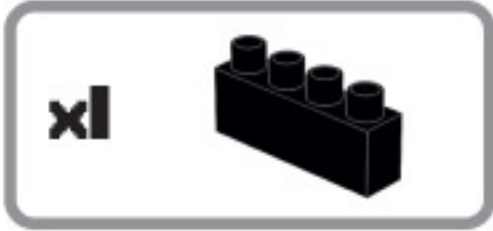
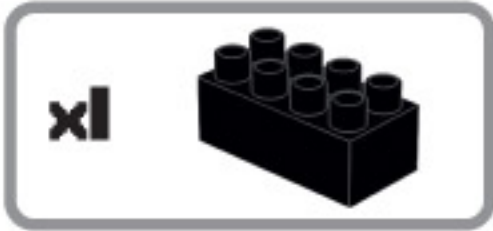

14

x1



x2

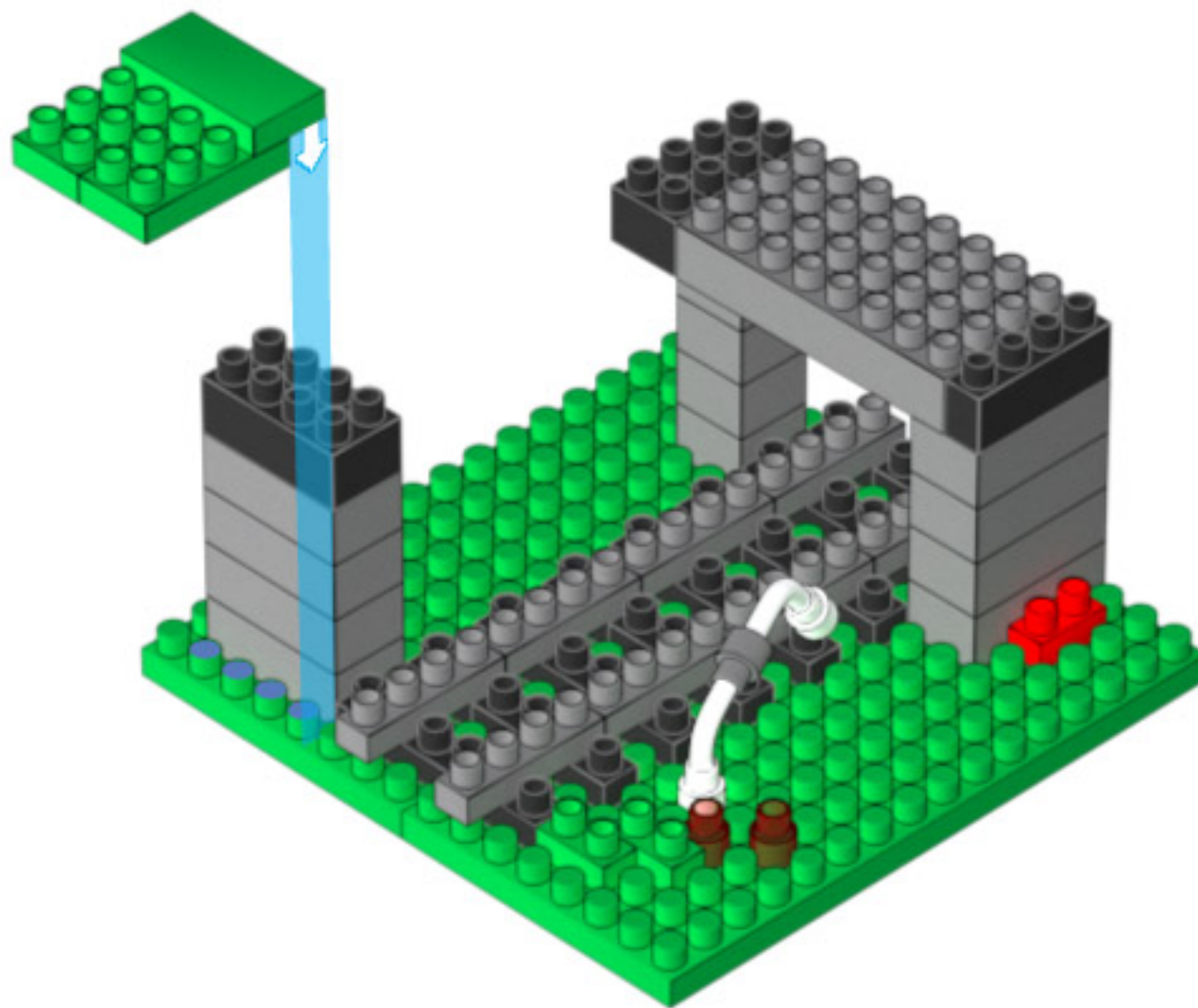

15

x5

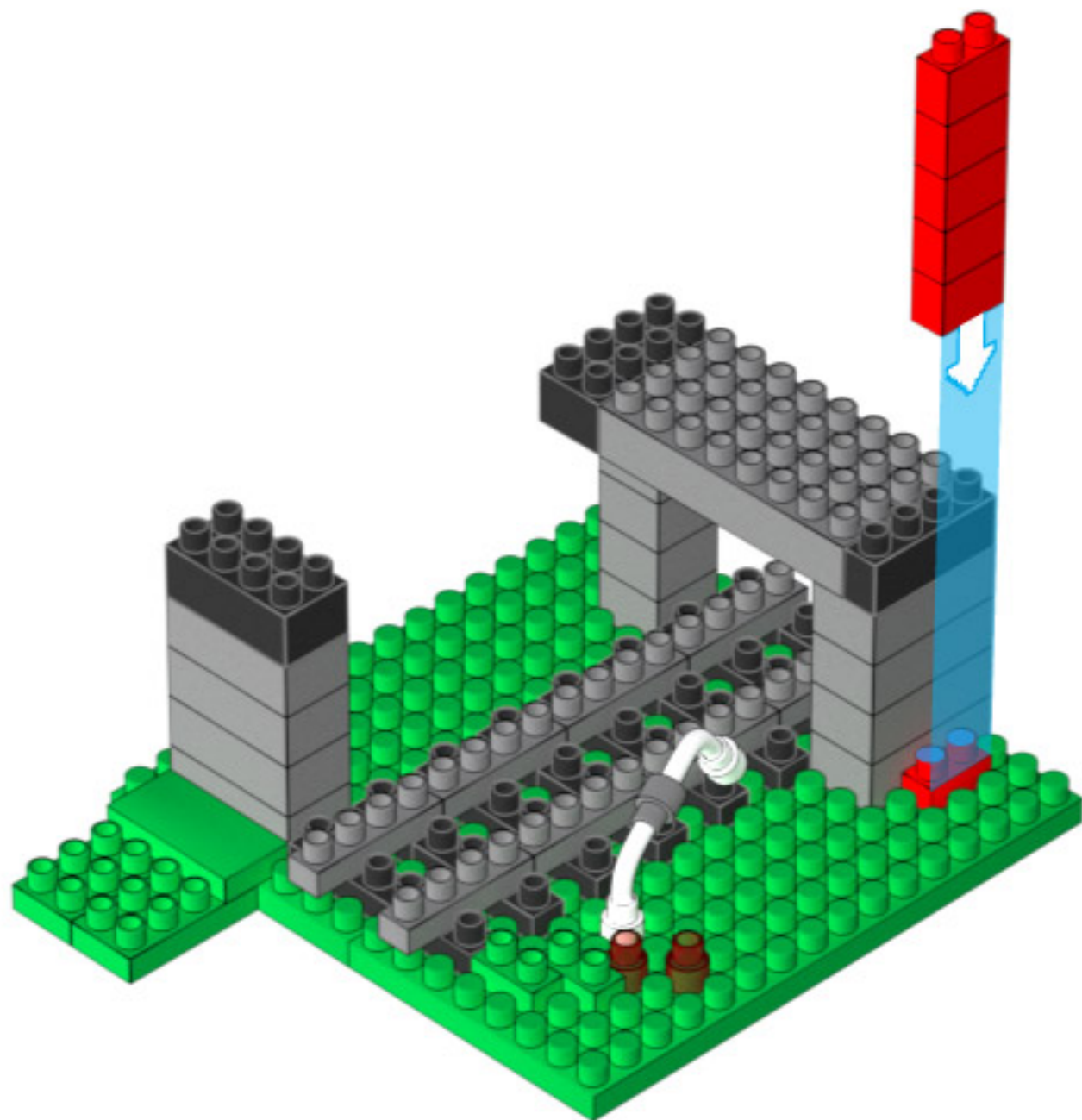
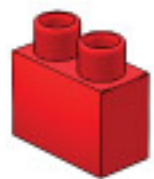

16

x1



x1

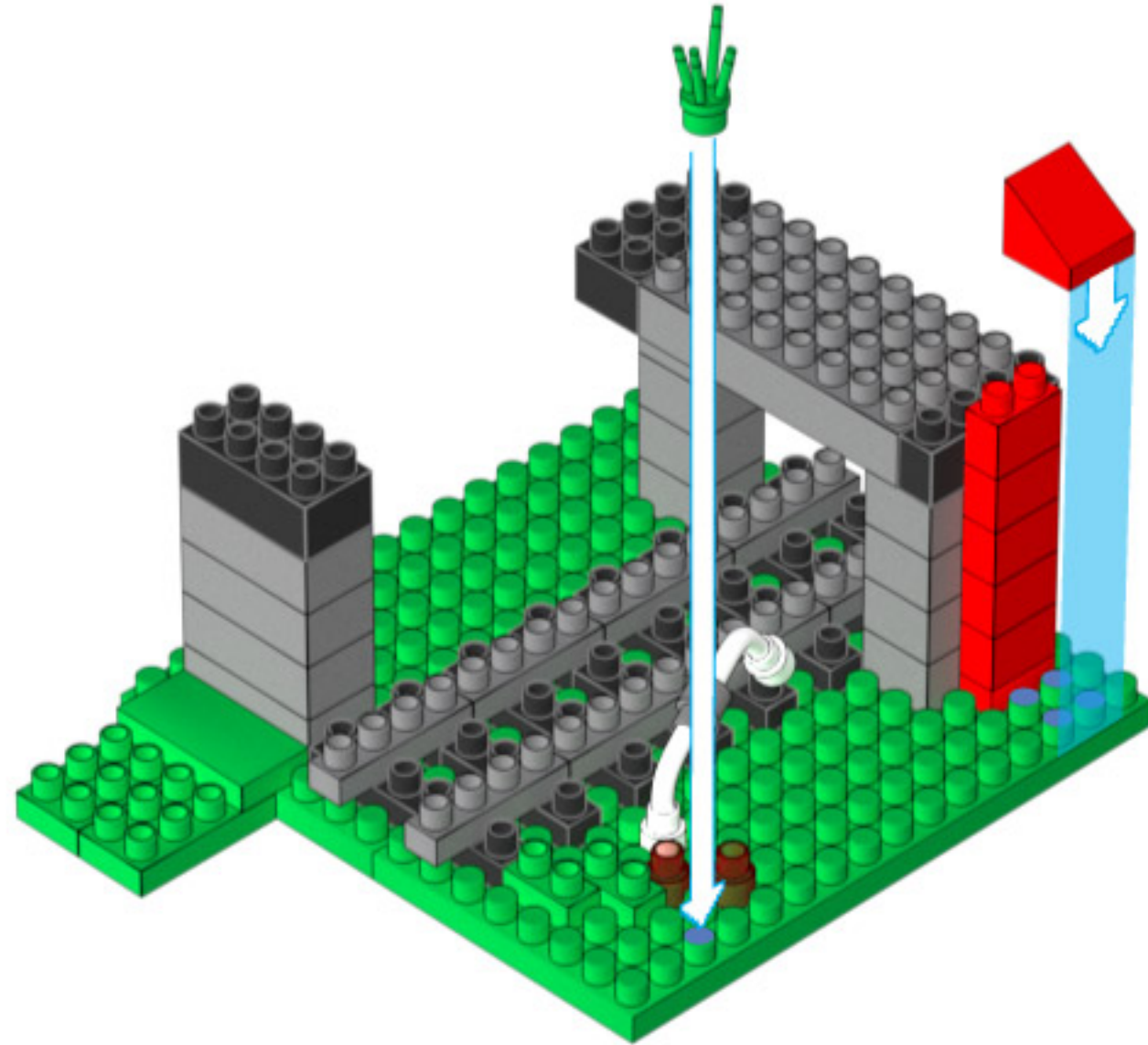

17

x1

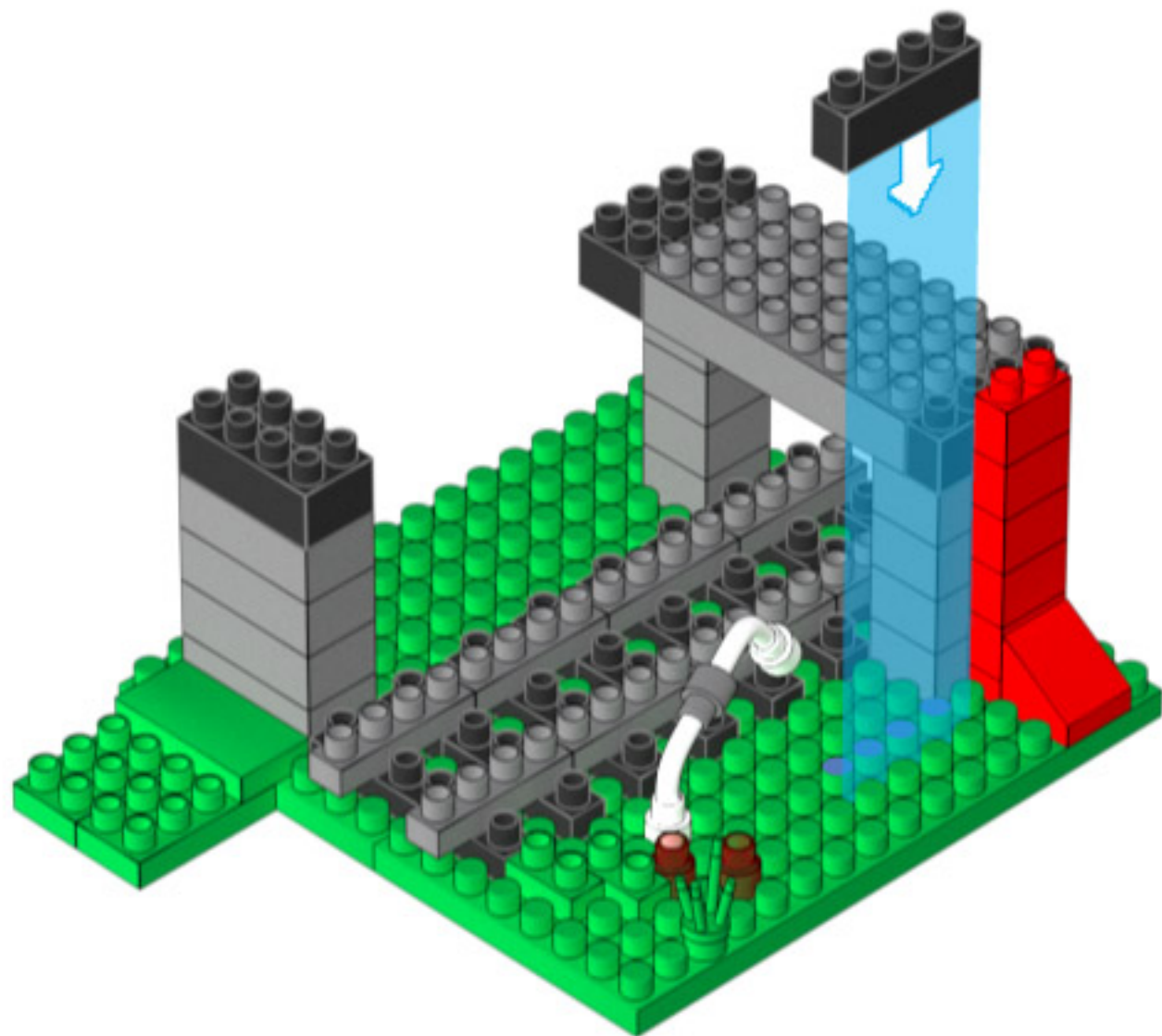
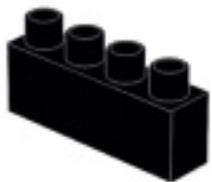

18

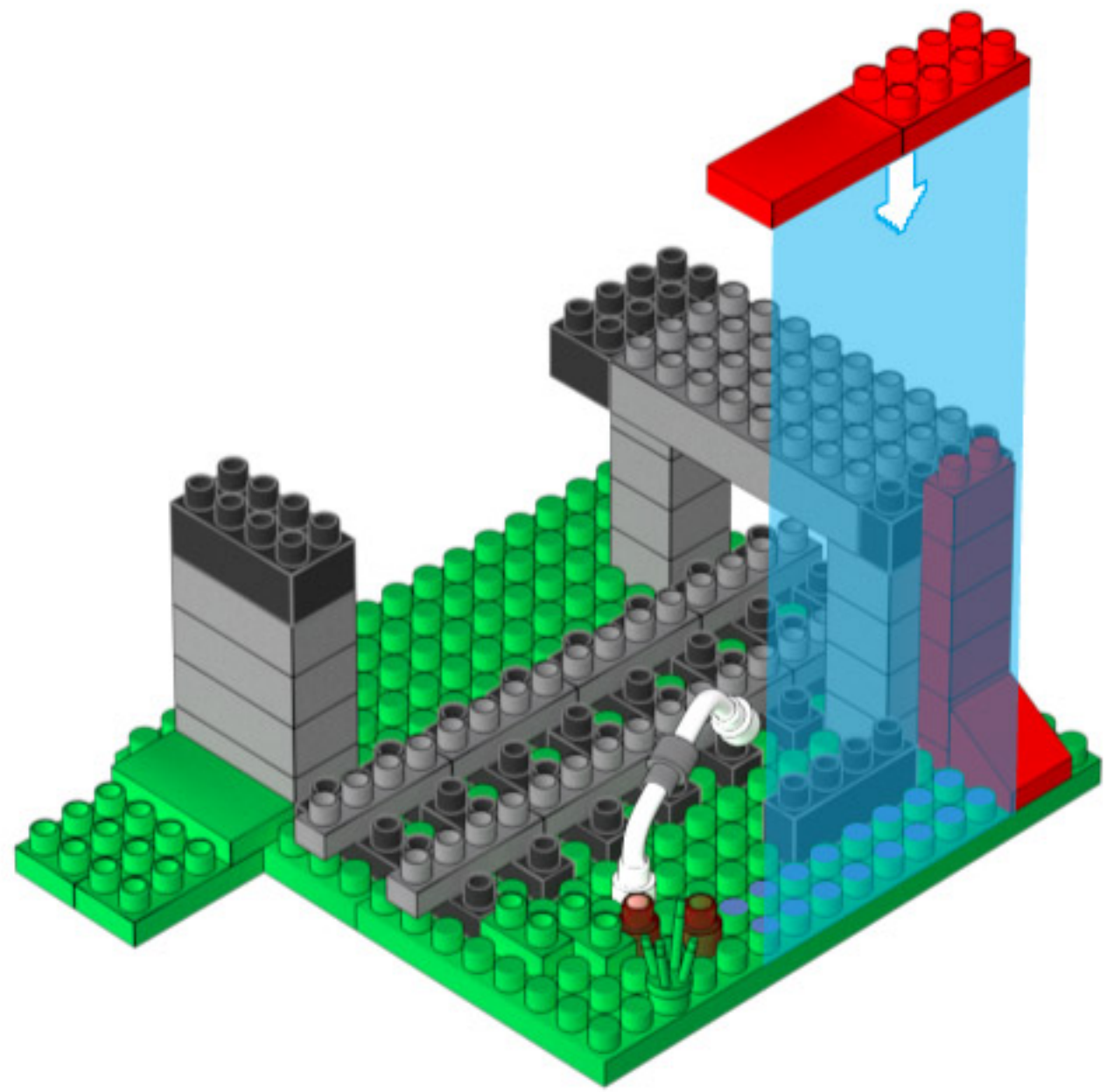
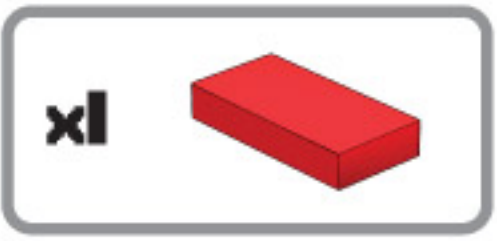
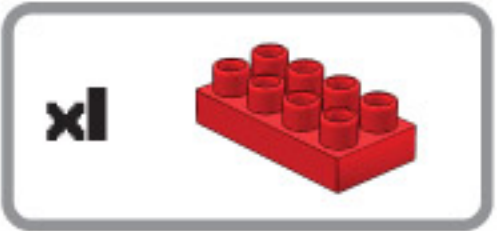

19

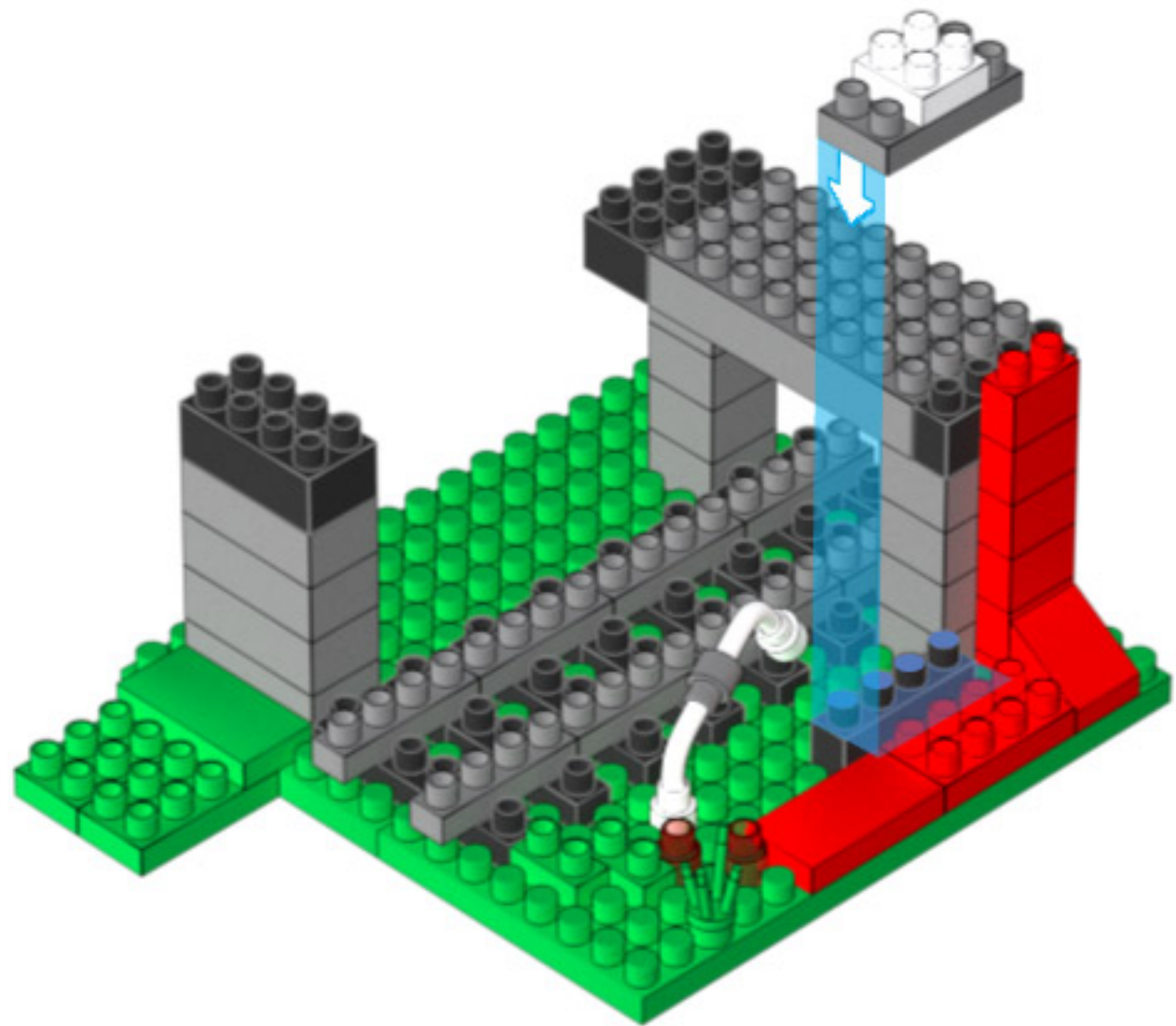
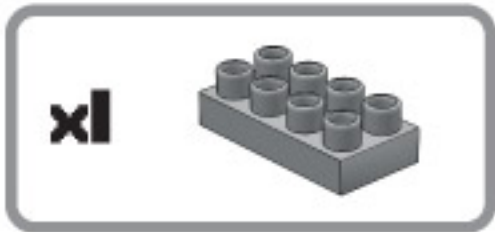
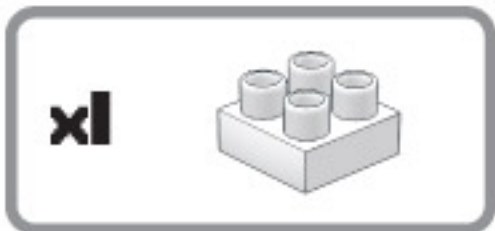

20

x3

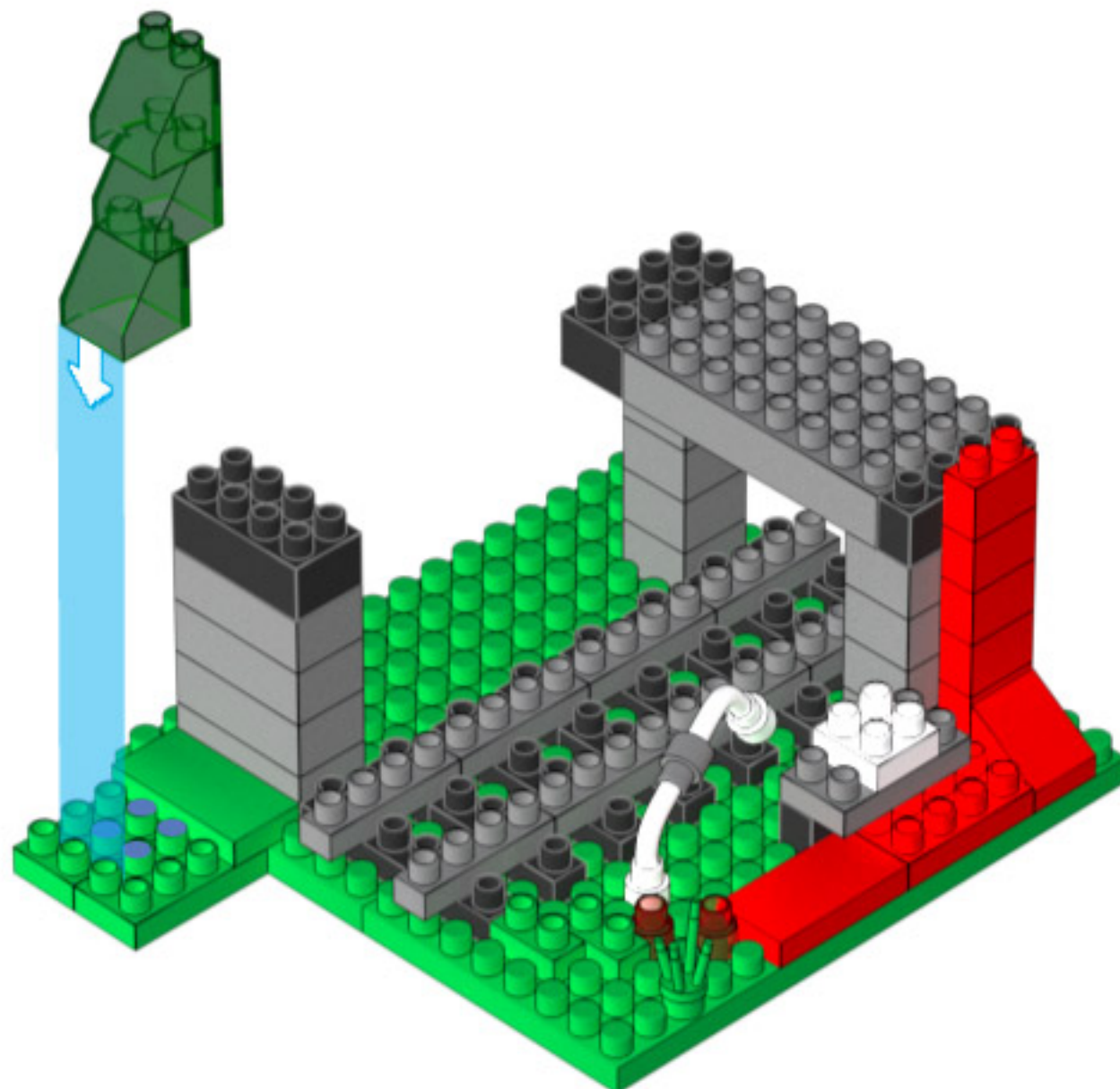

21

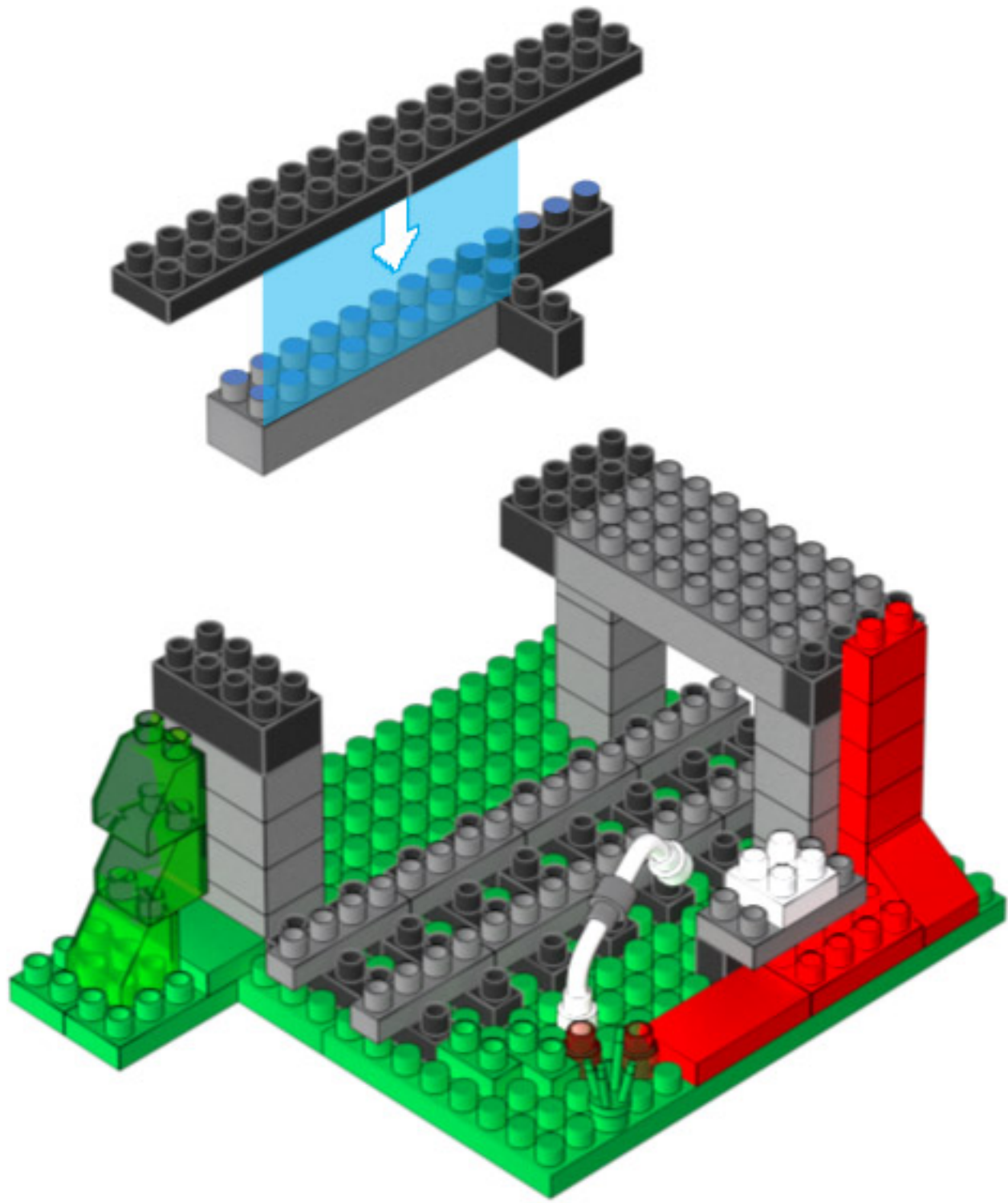
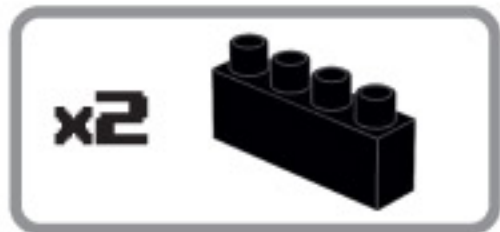
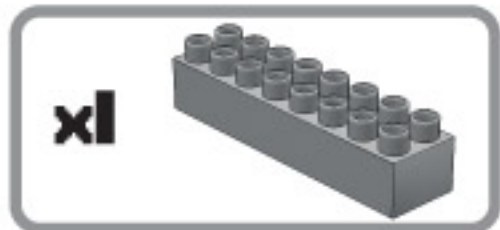

22

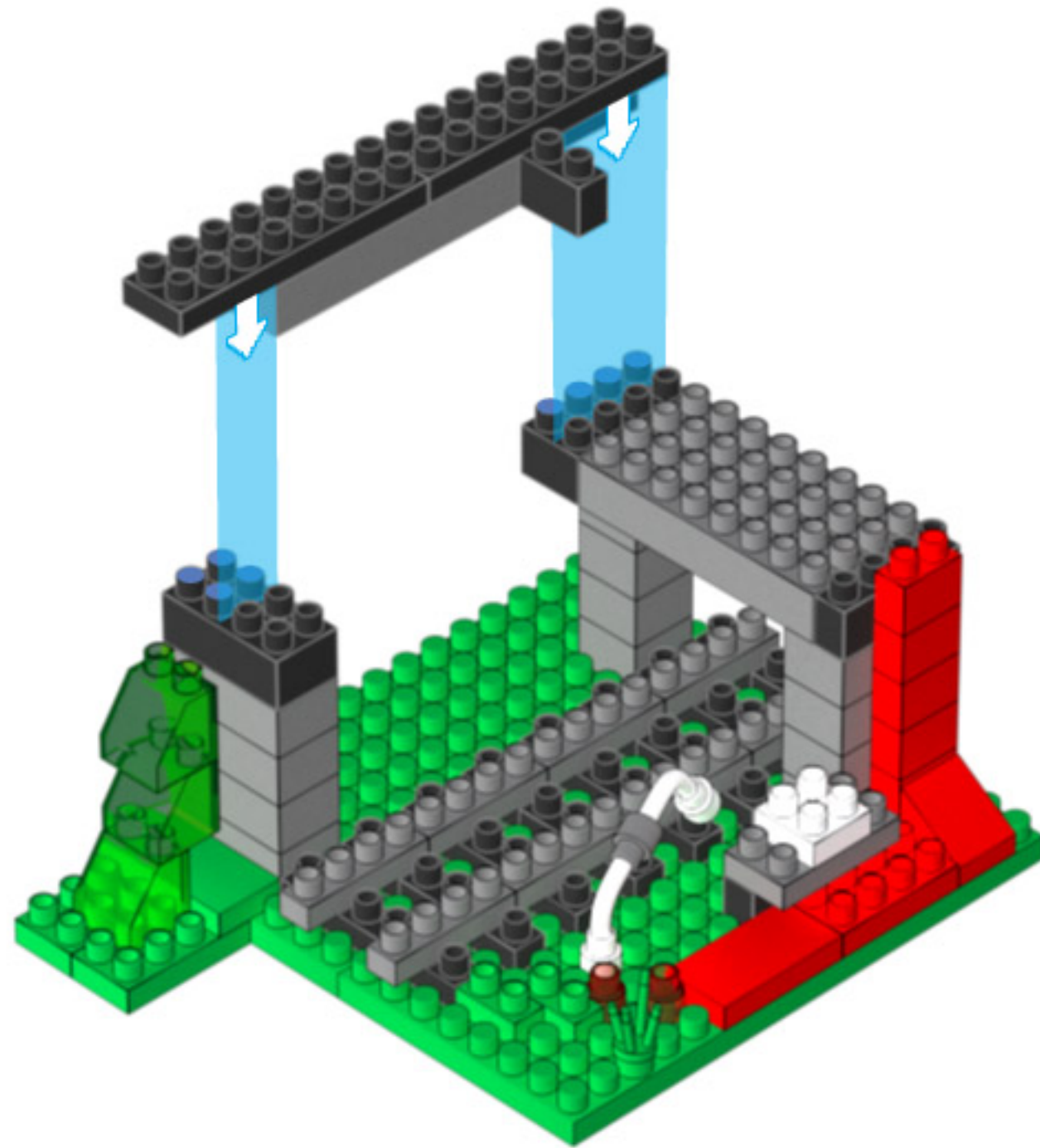

23

x1

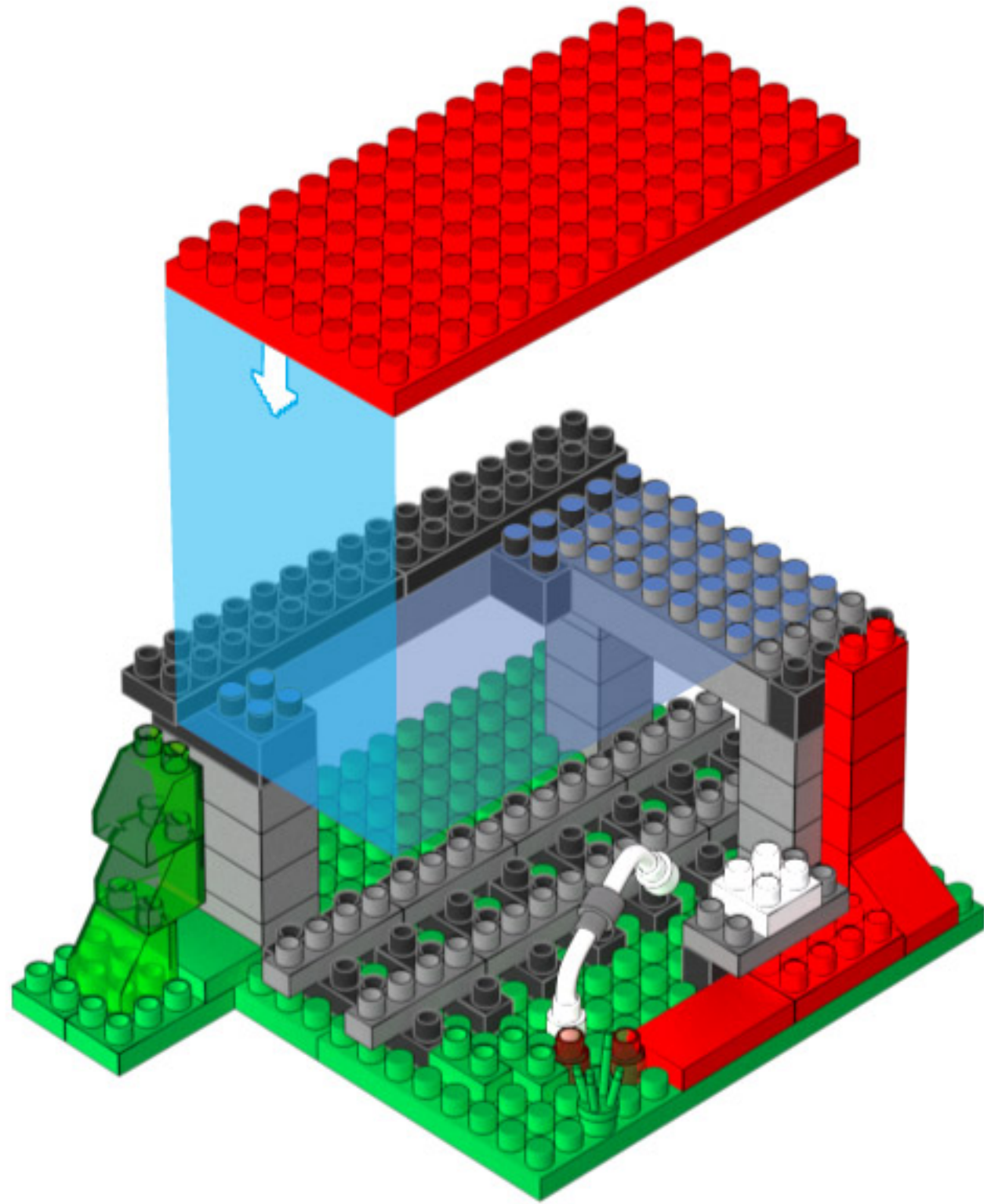
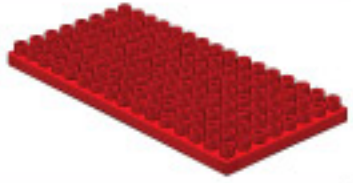

24

x1



x1



x1

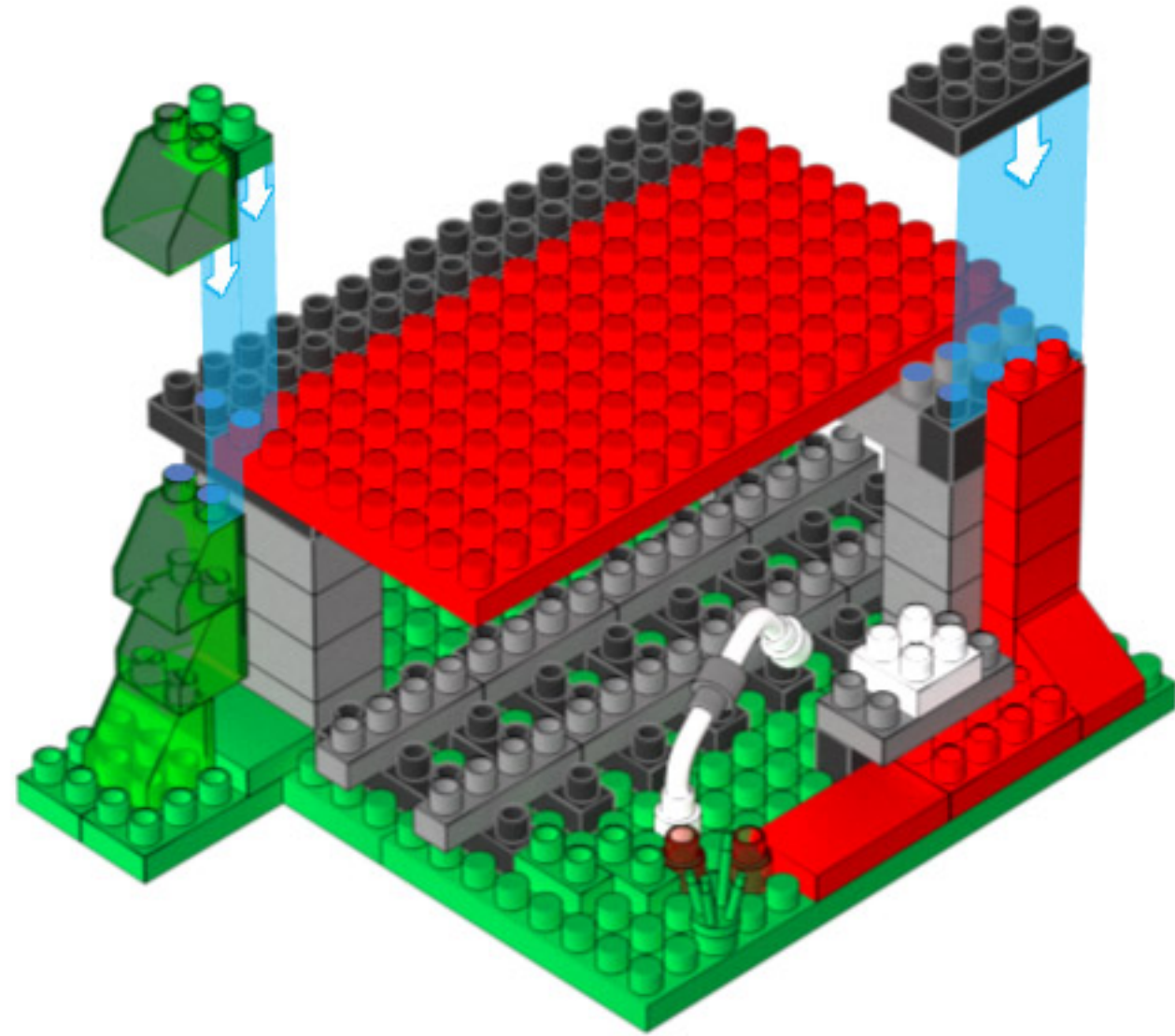

25

x1



x1

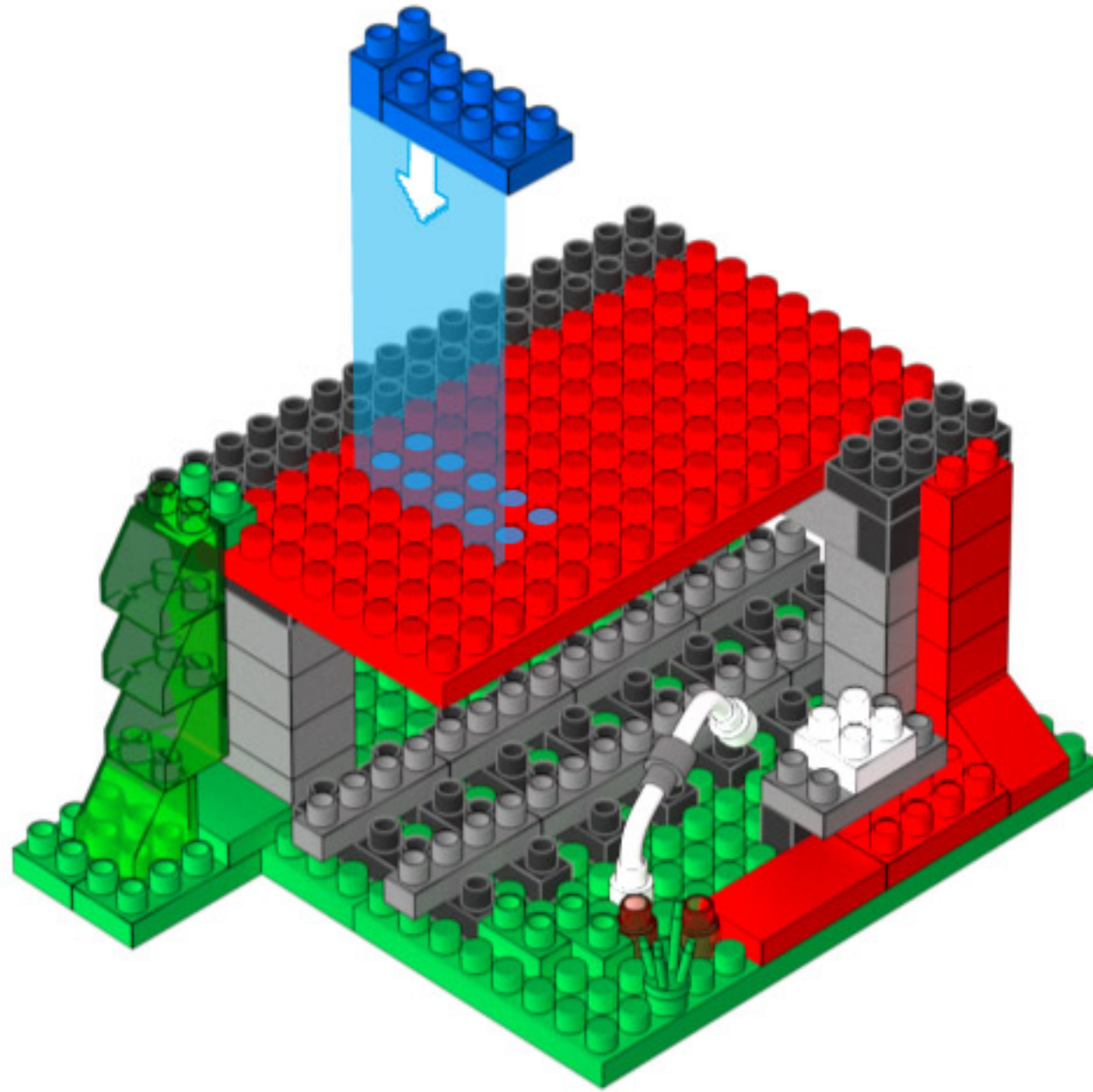
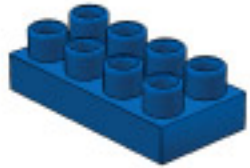

26

x1



x1

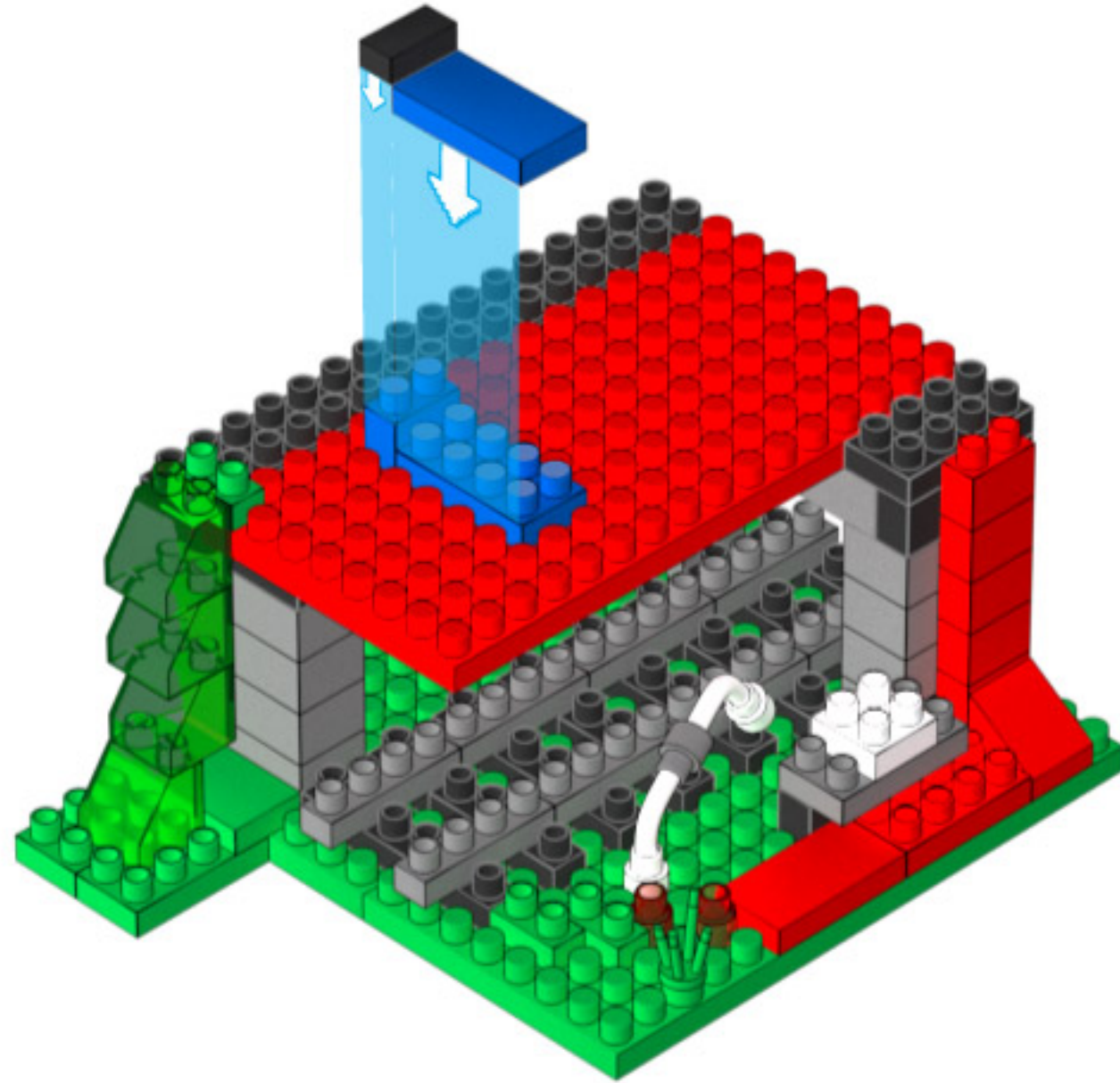
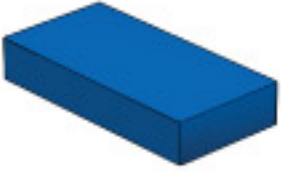

27

x4

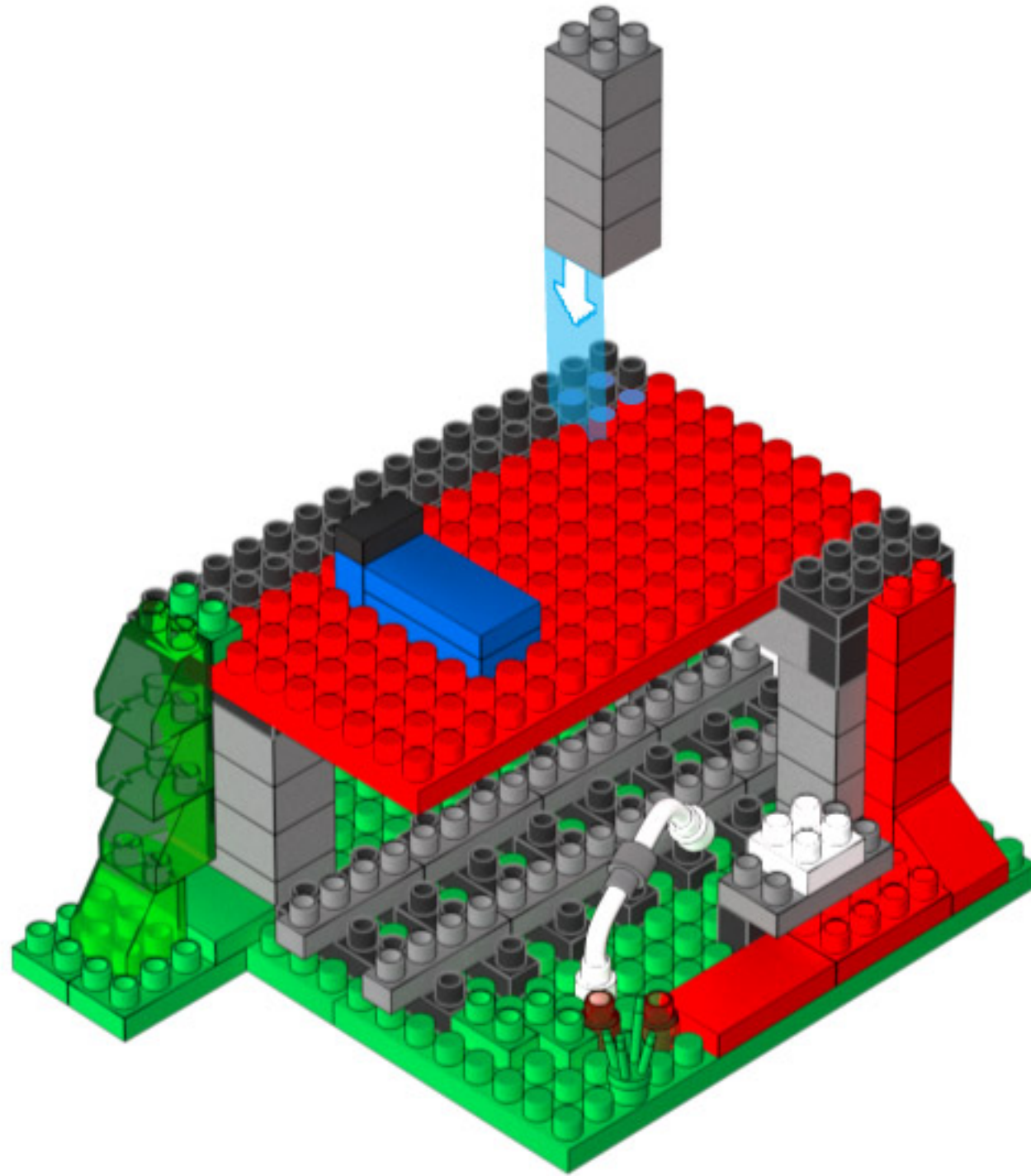

28

x3

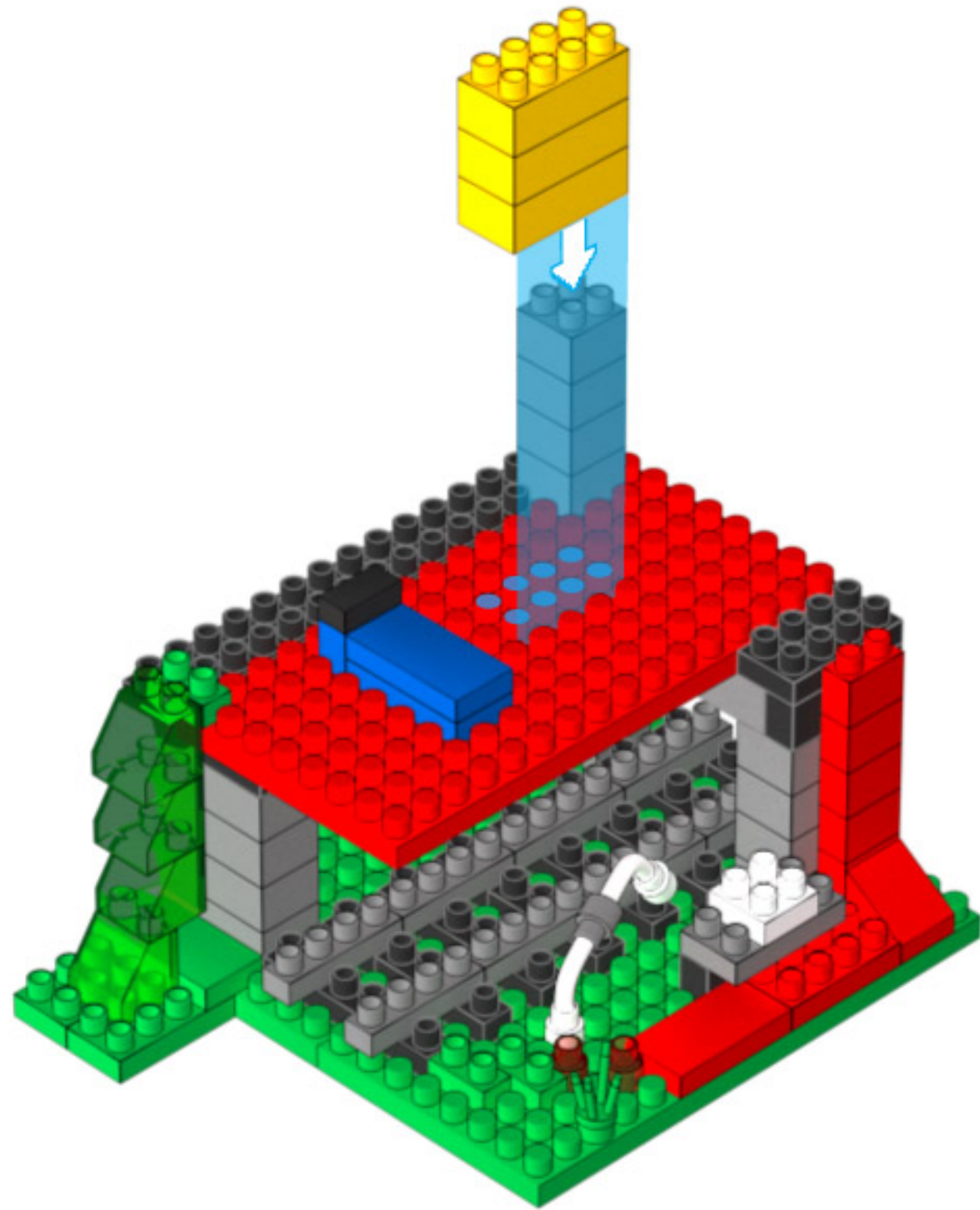
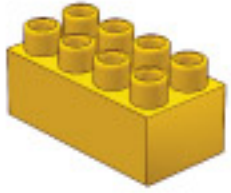

29

x8

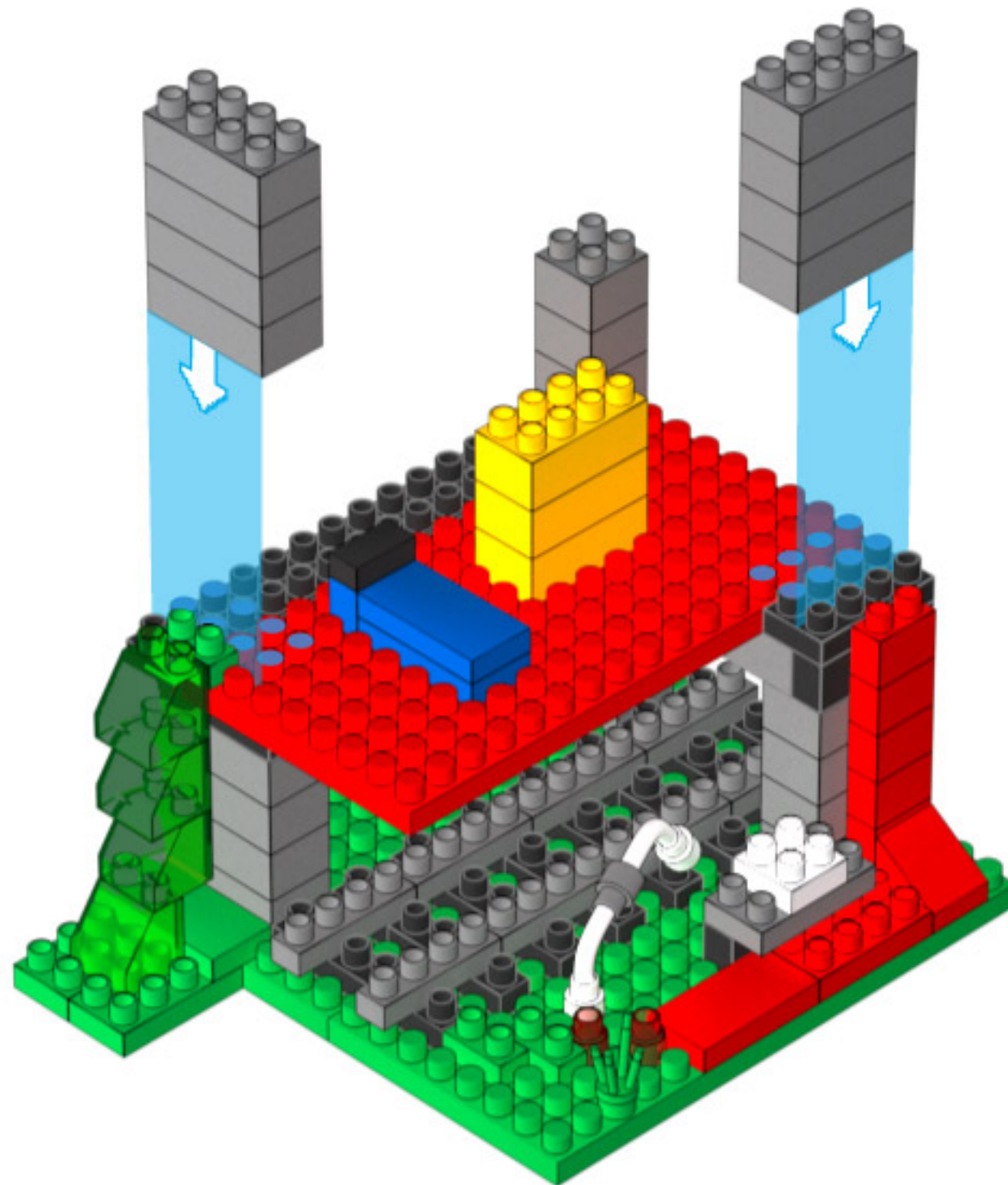

30

x1



x1

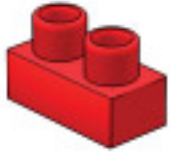

x1

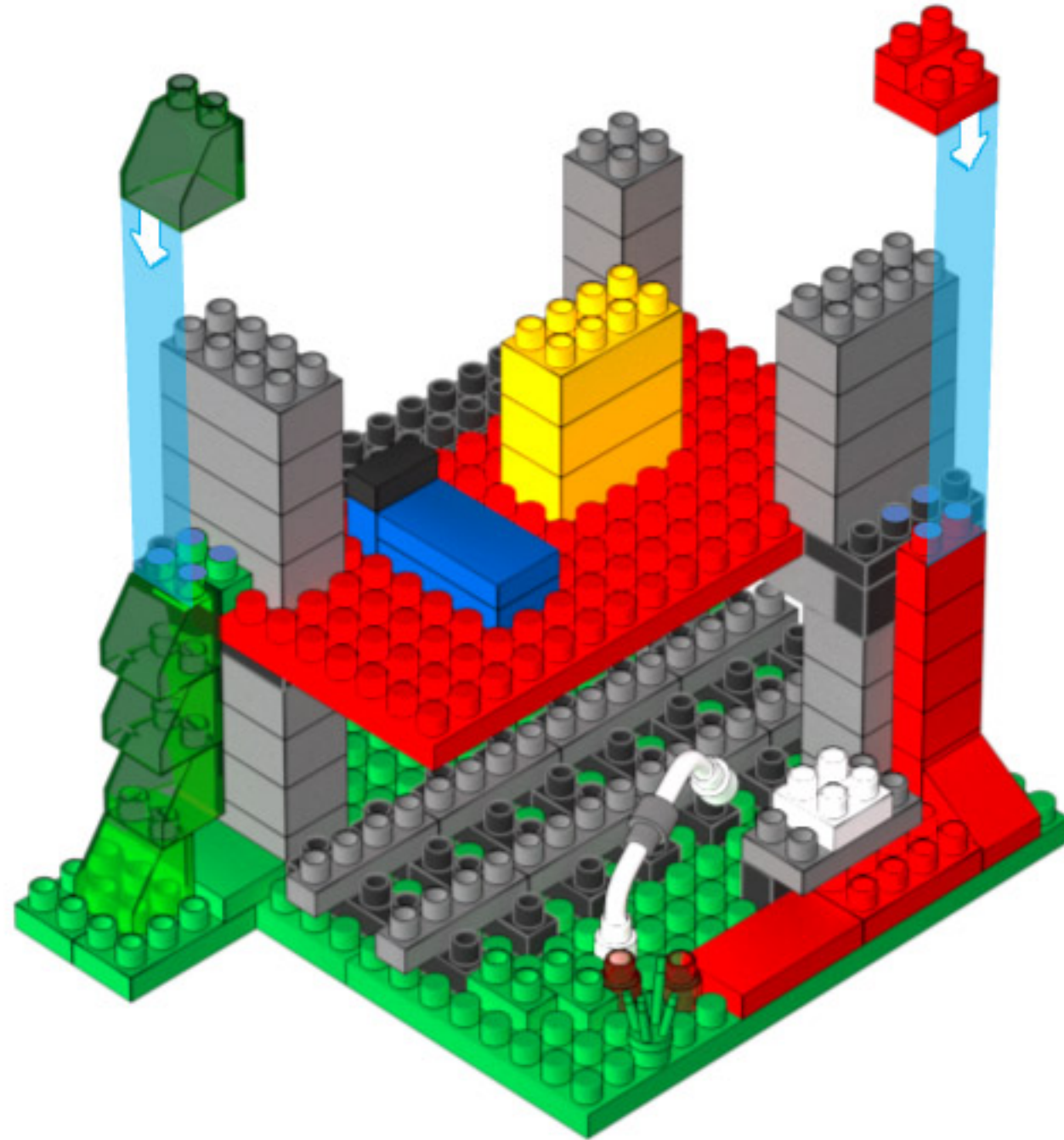

31

x1

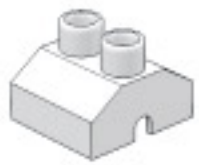

x1

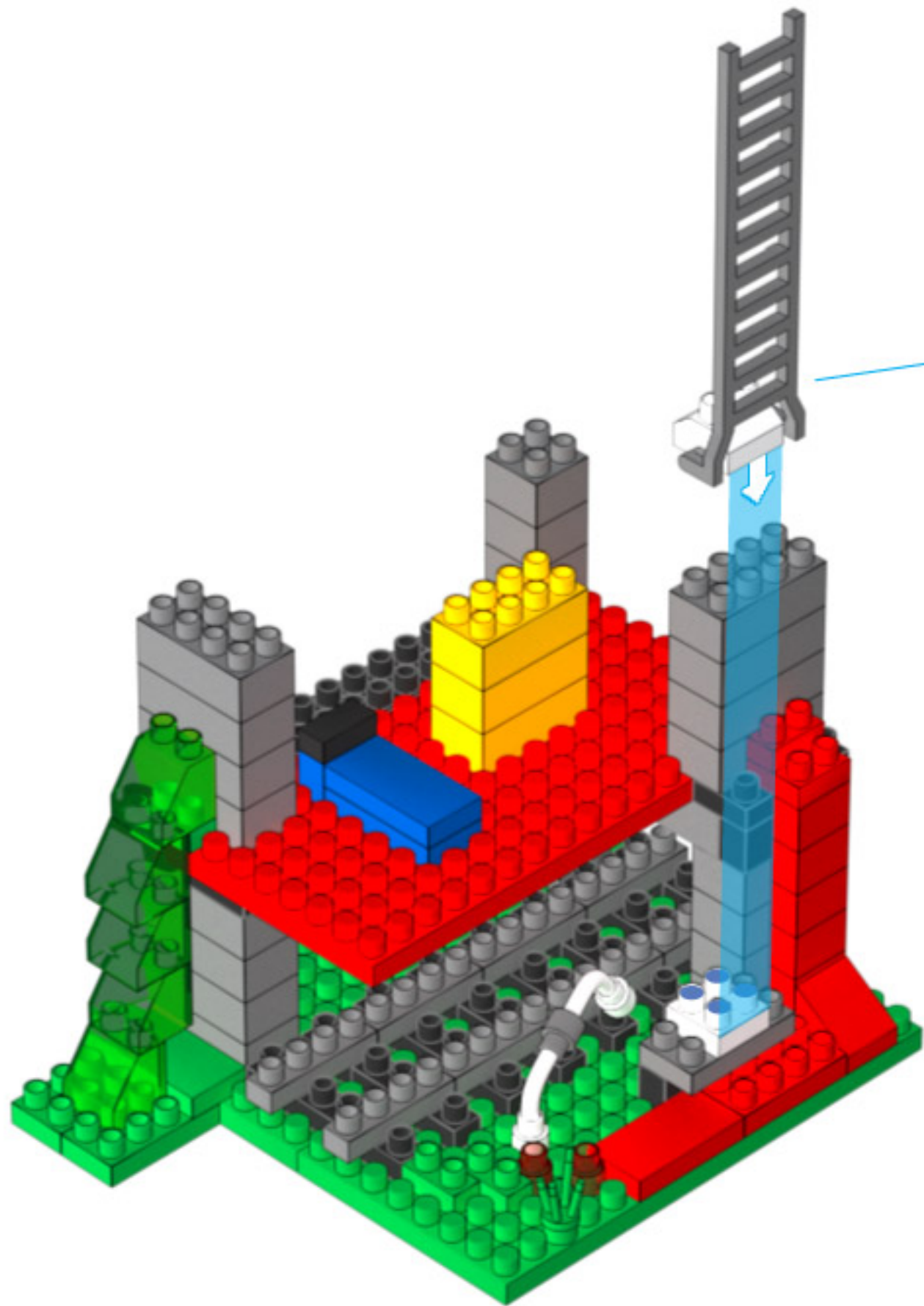

**DETALLE DE
SOPORTE DE
ESCALERA**

32

x2

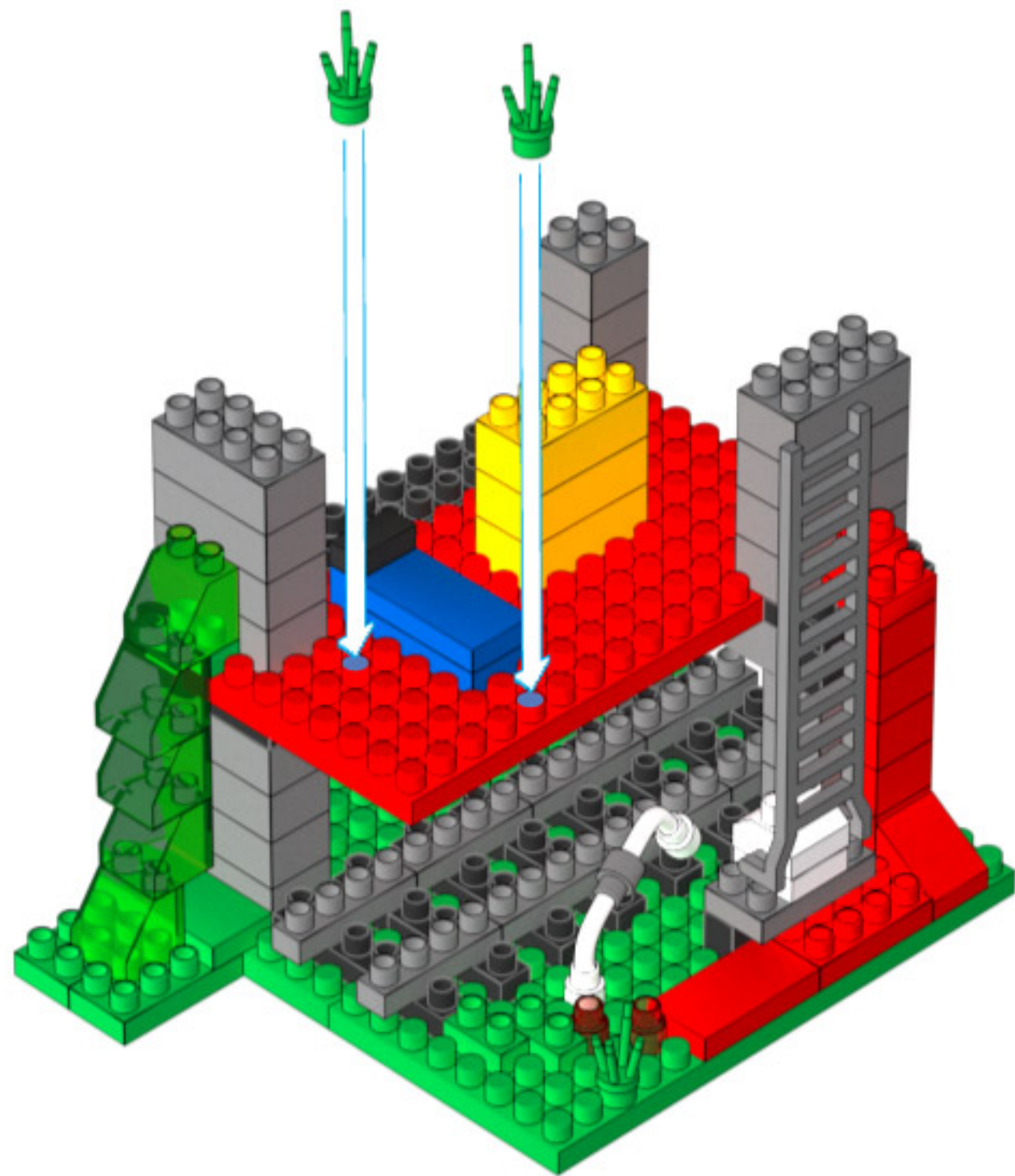

33

x1

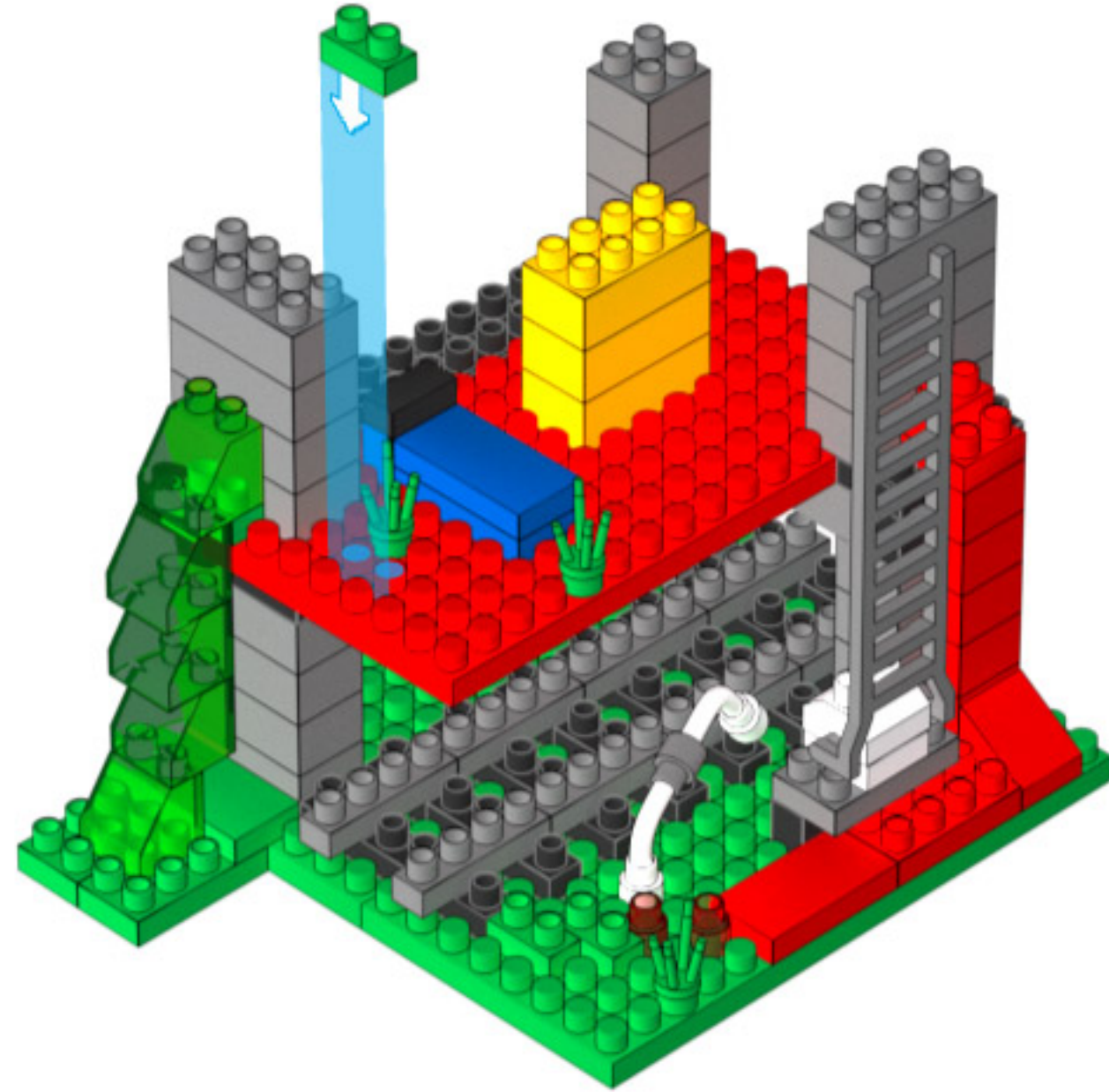

34

x2

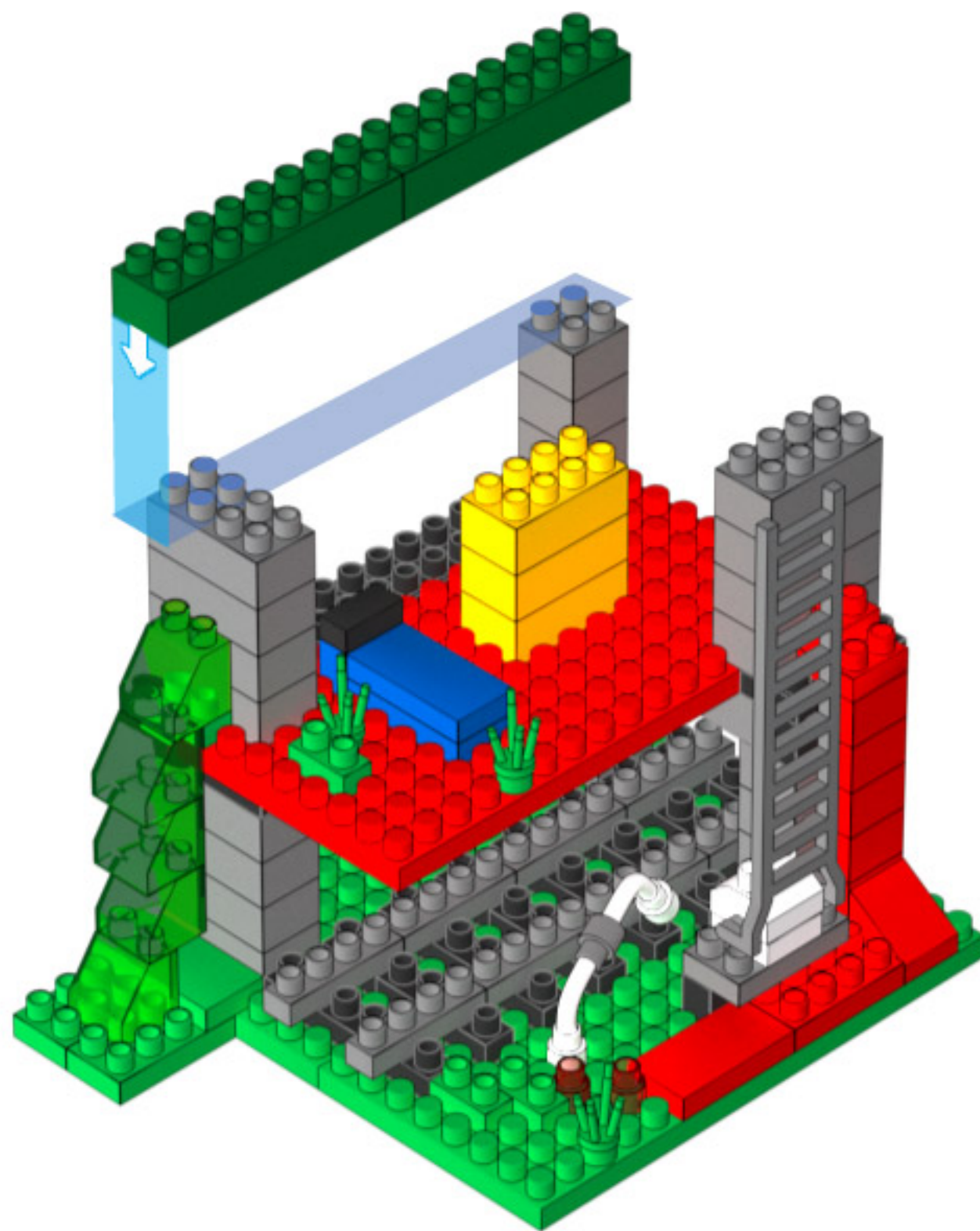

35

x1



x1

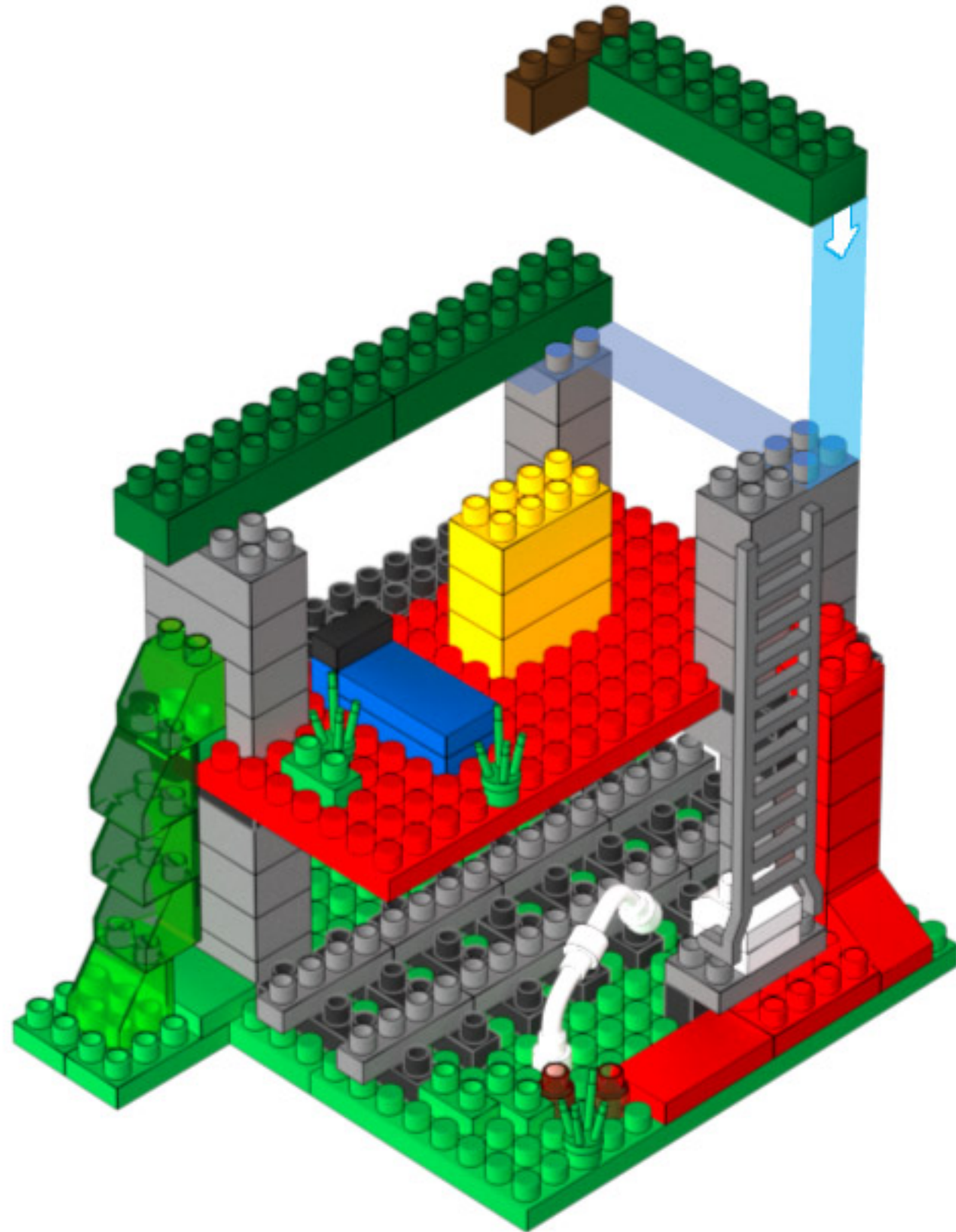

36

x2

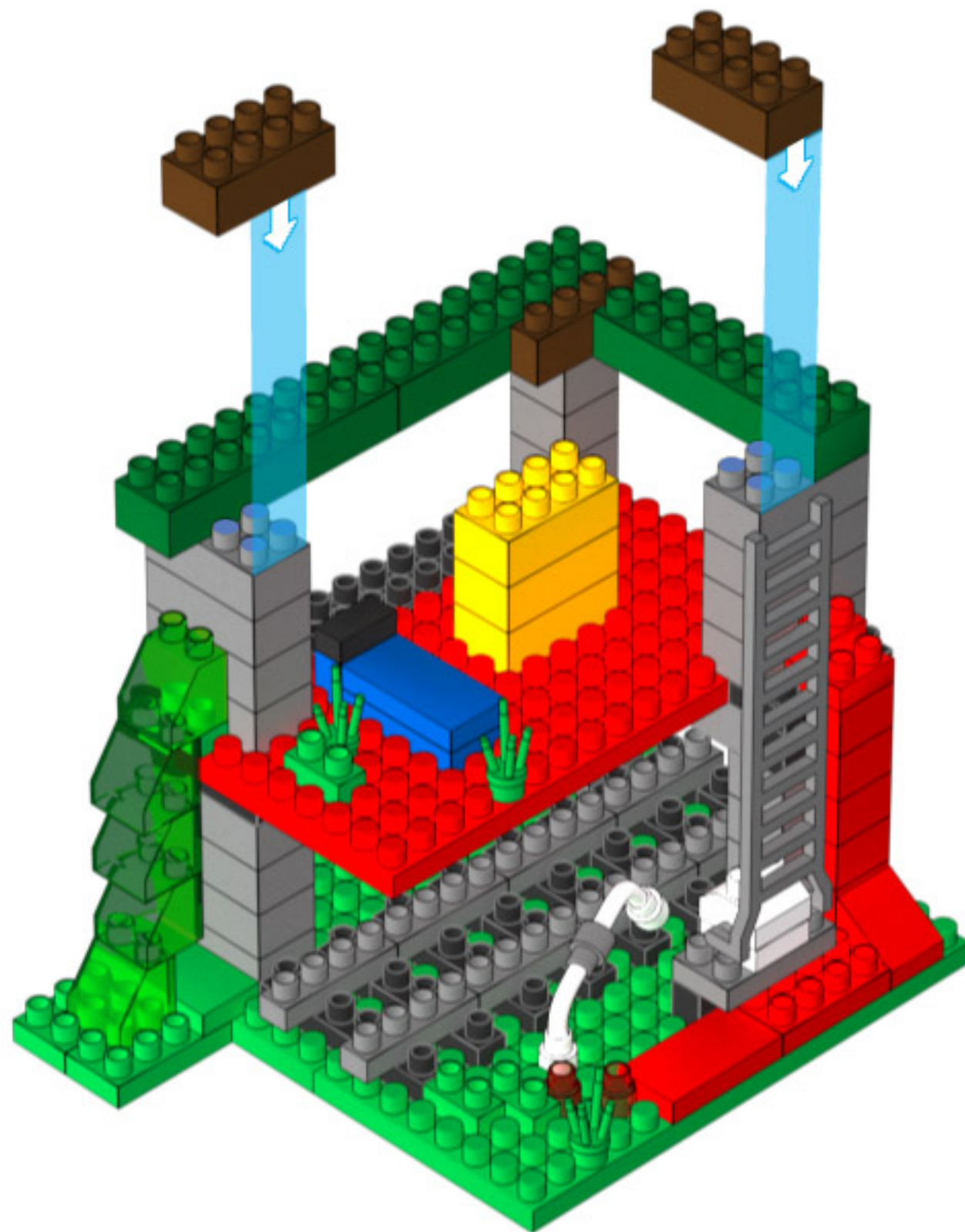

37

x1

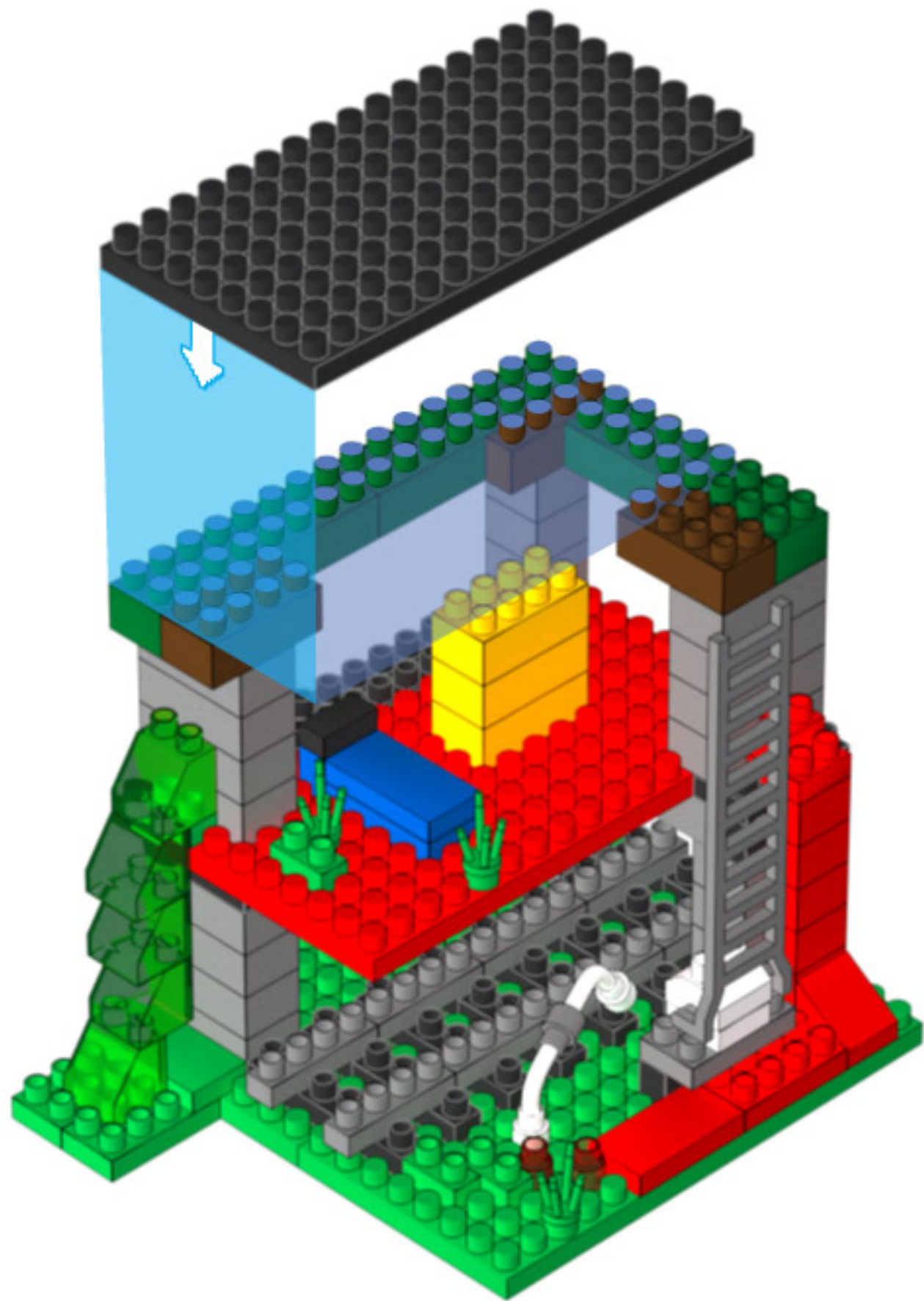
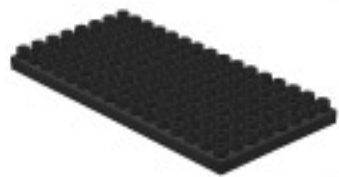

38

x1

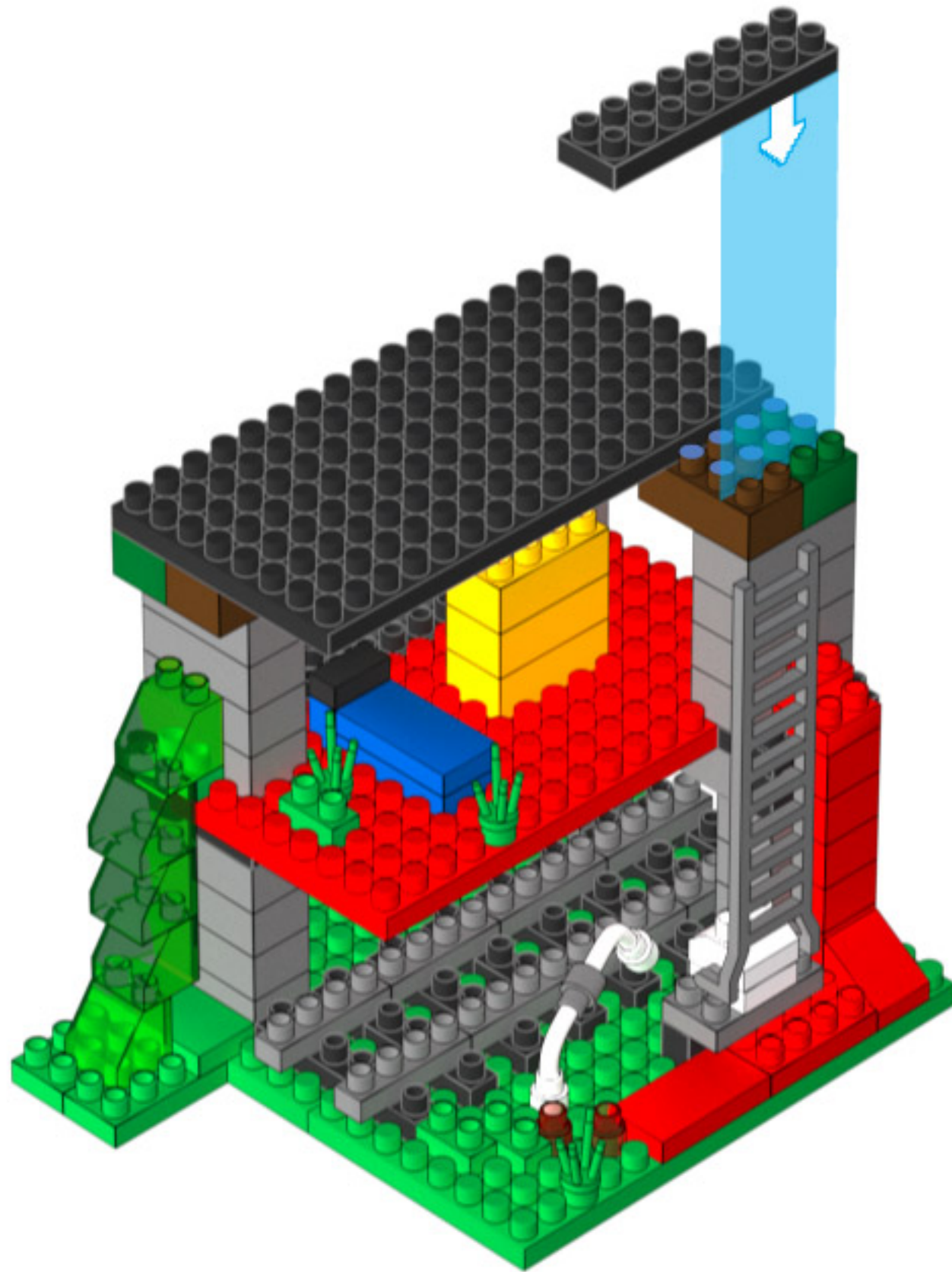

39

x2



x2

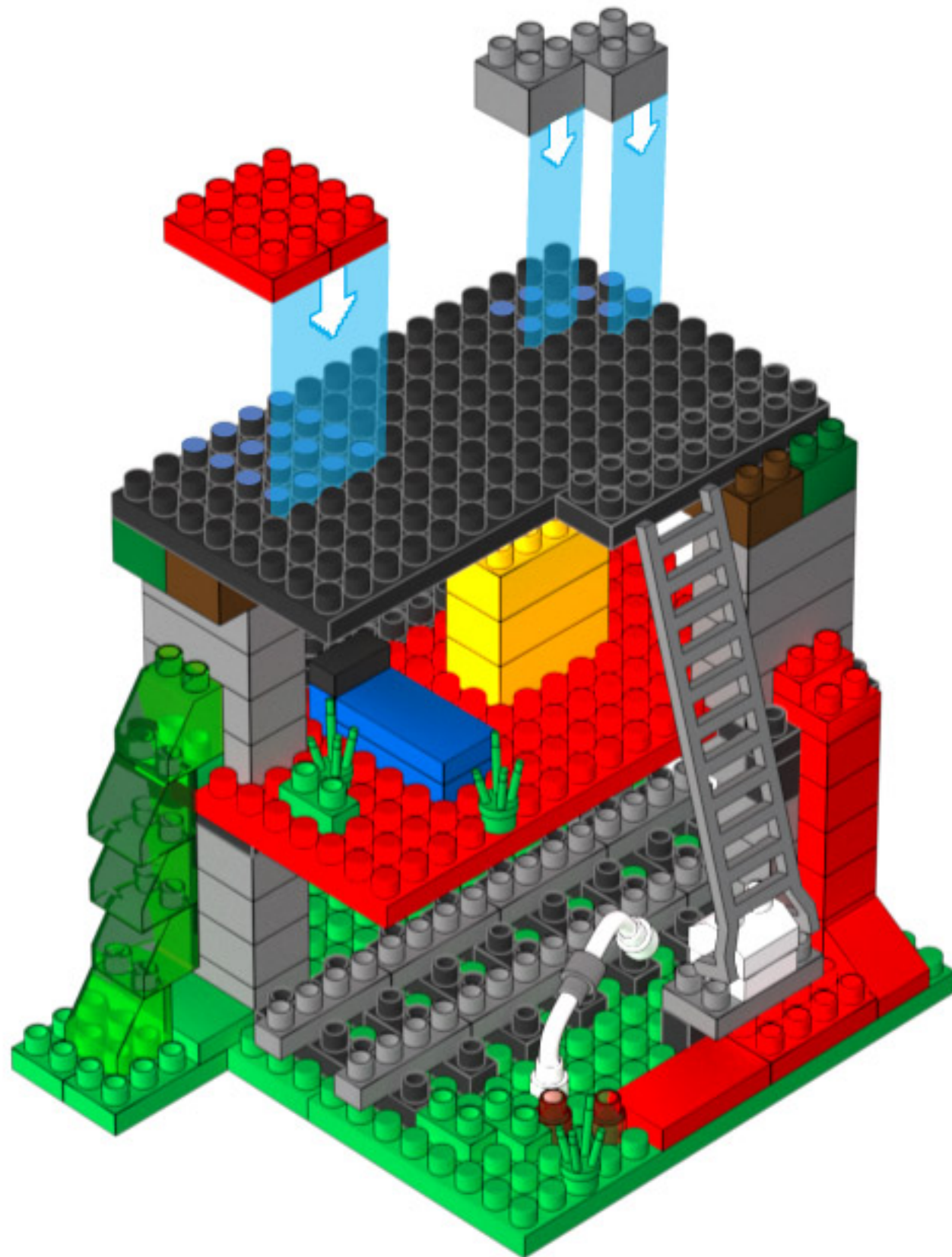

40

x8

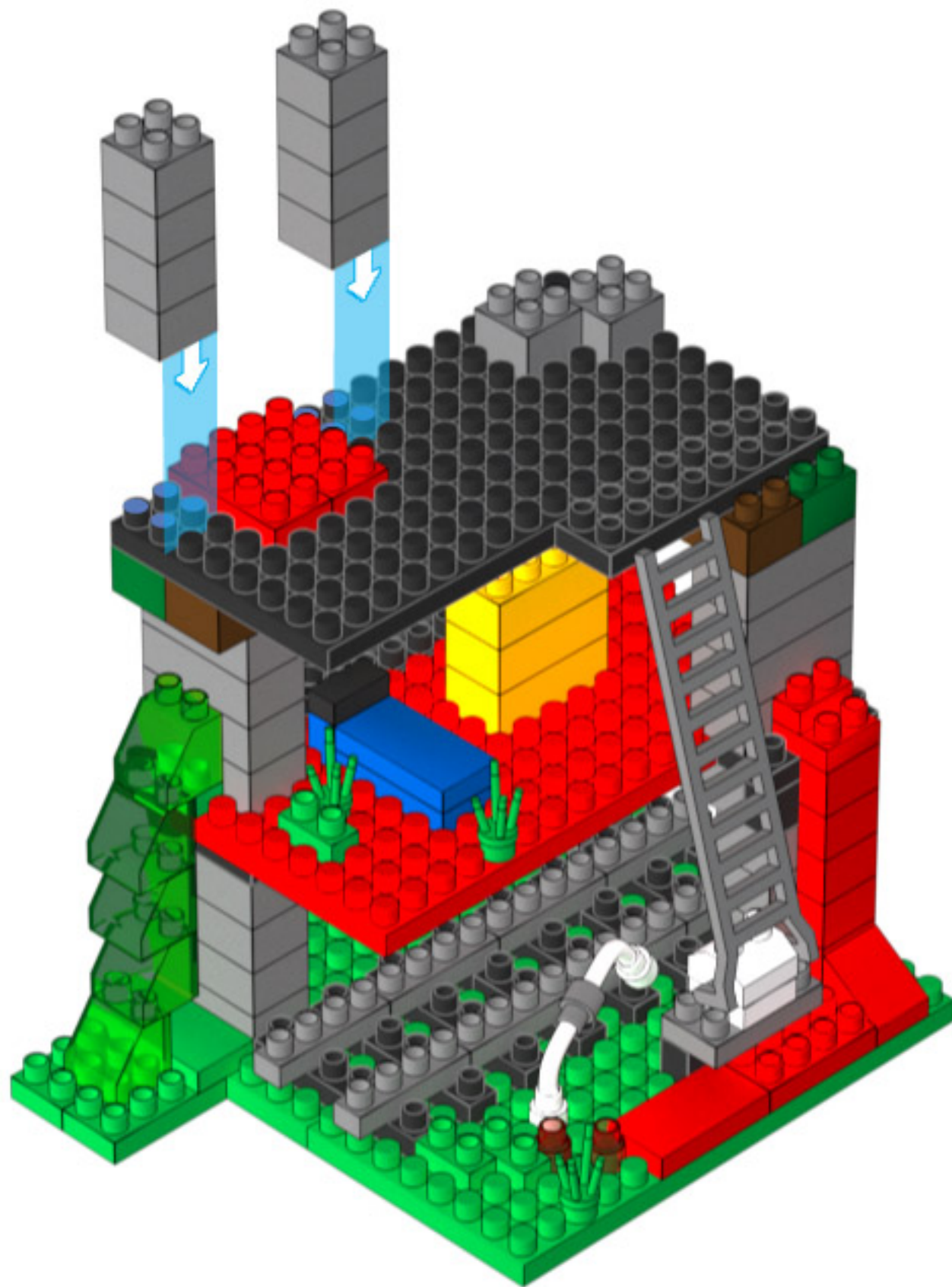

41

x4

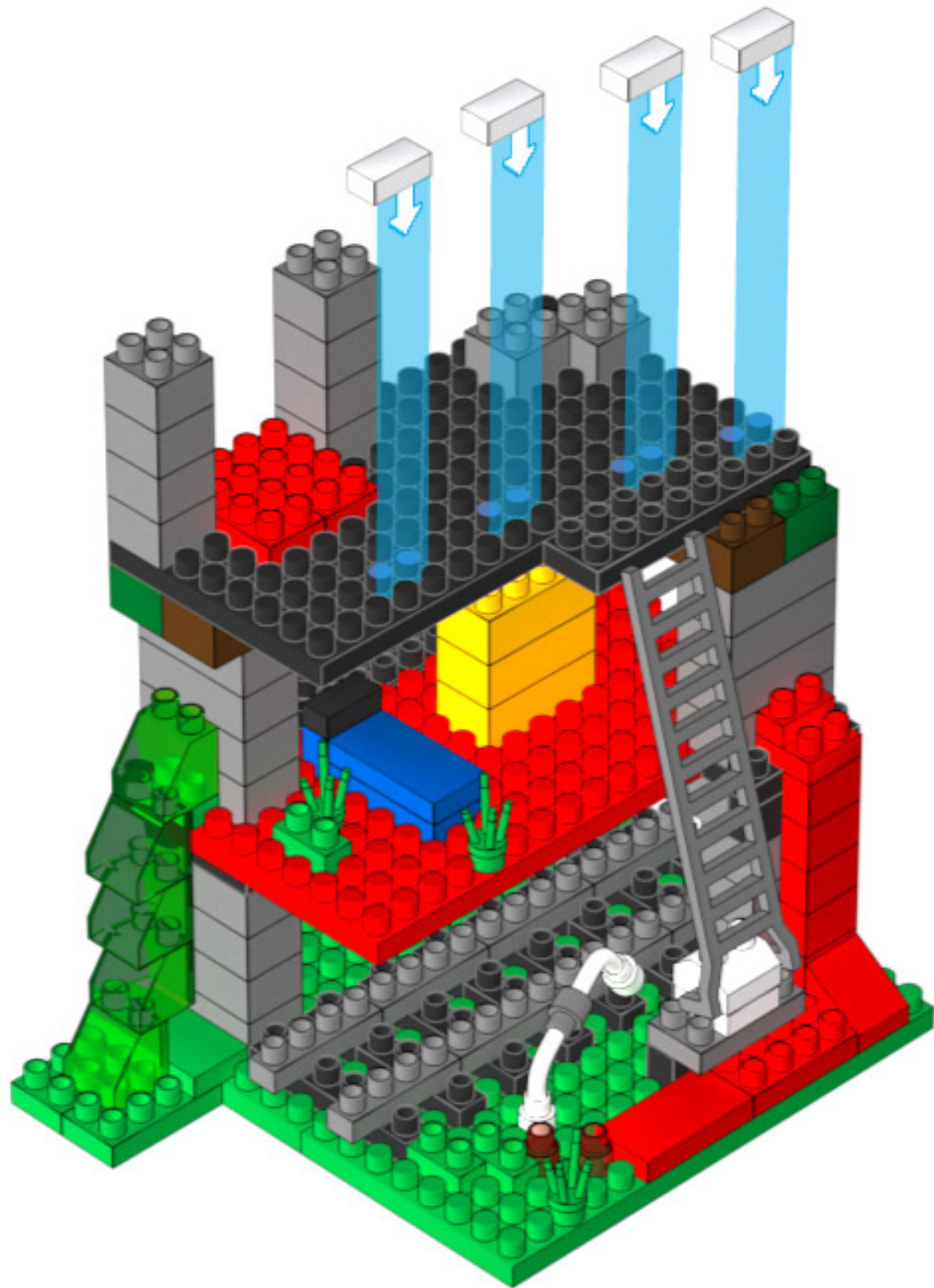
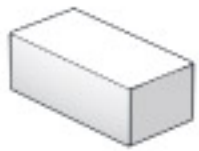

42

x2

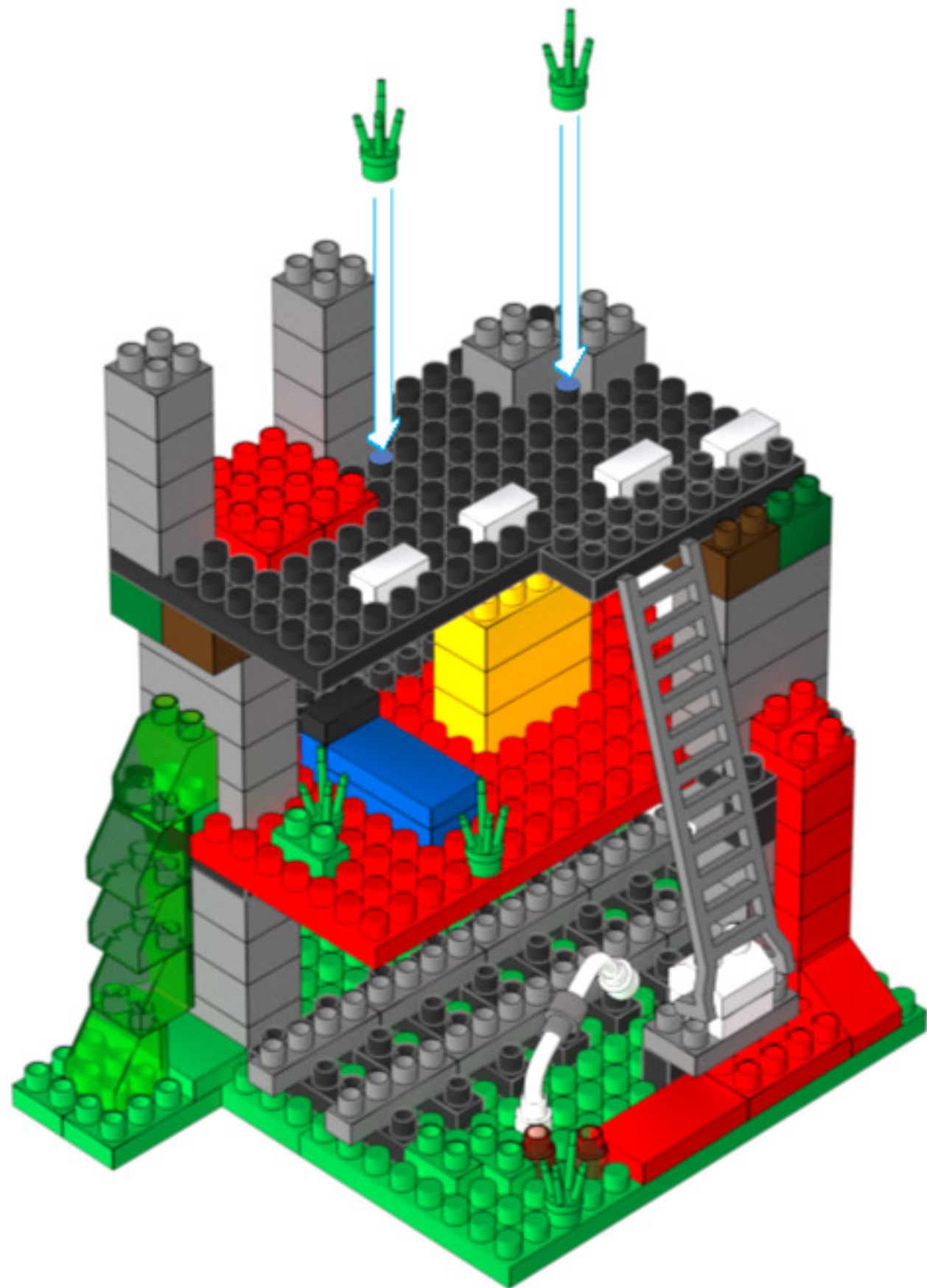

43

x1

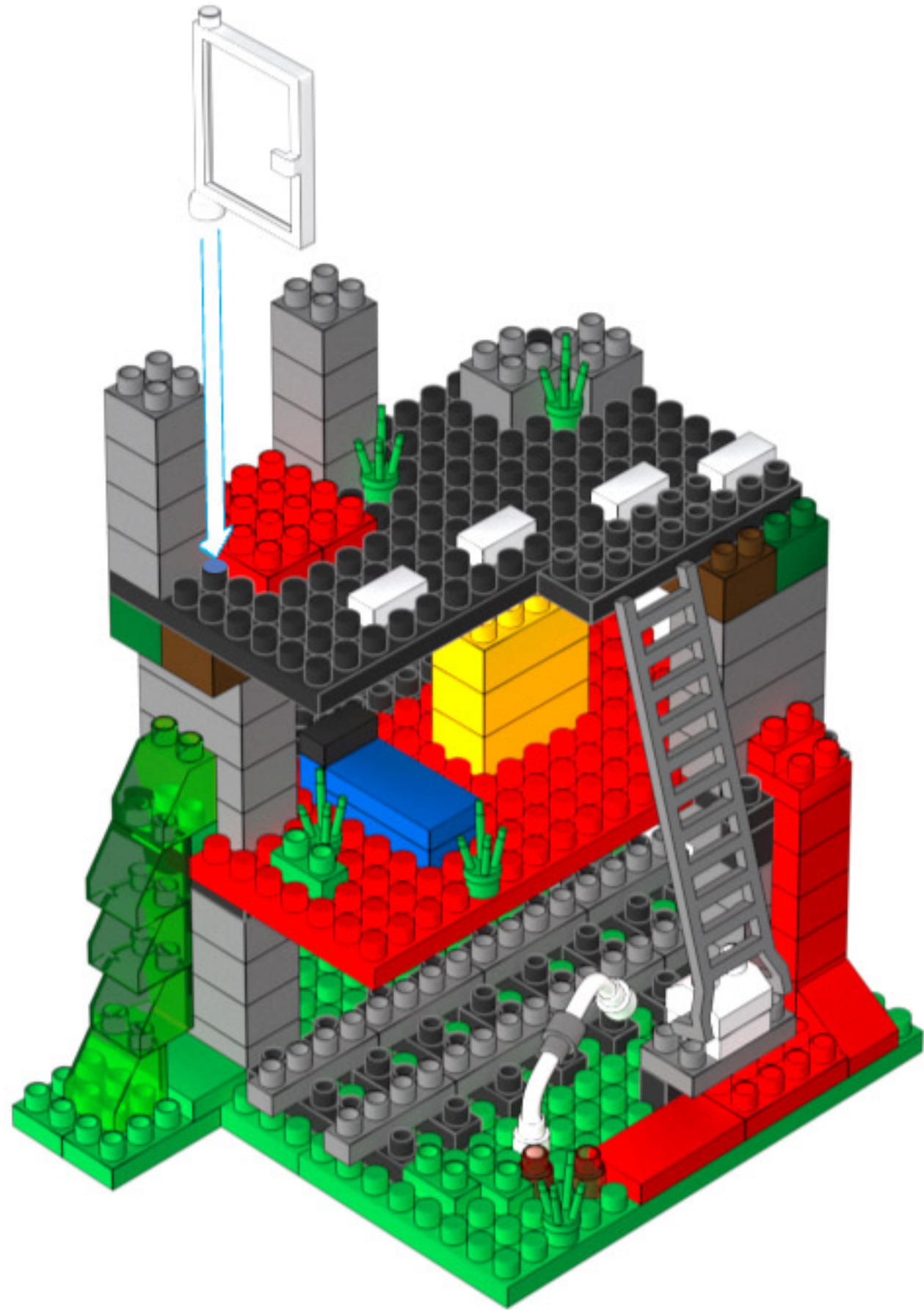

44

x2



x1

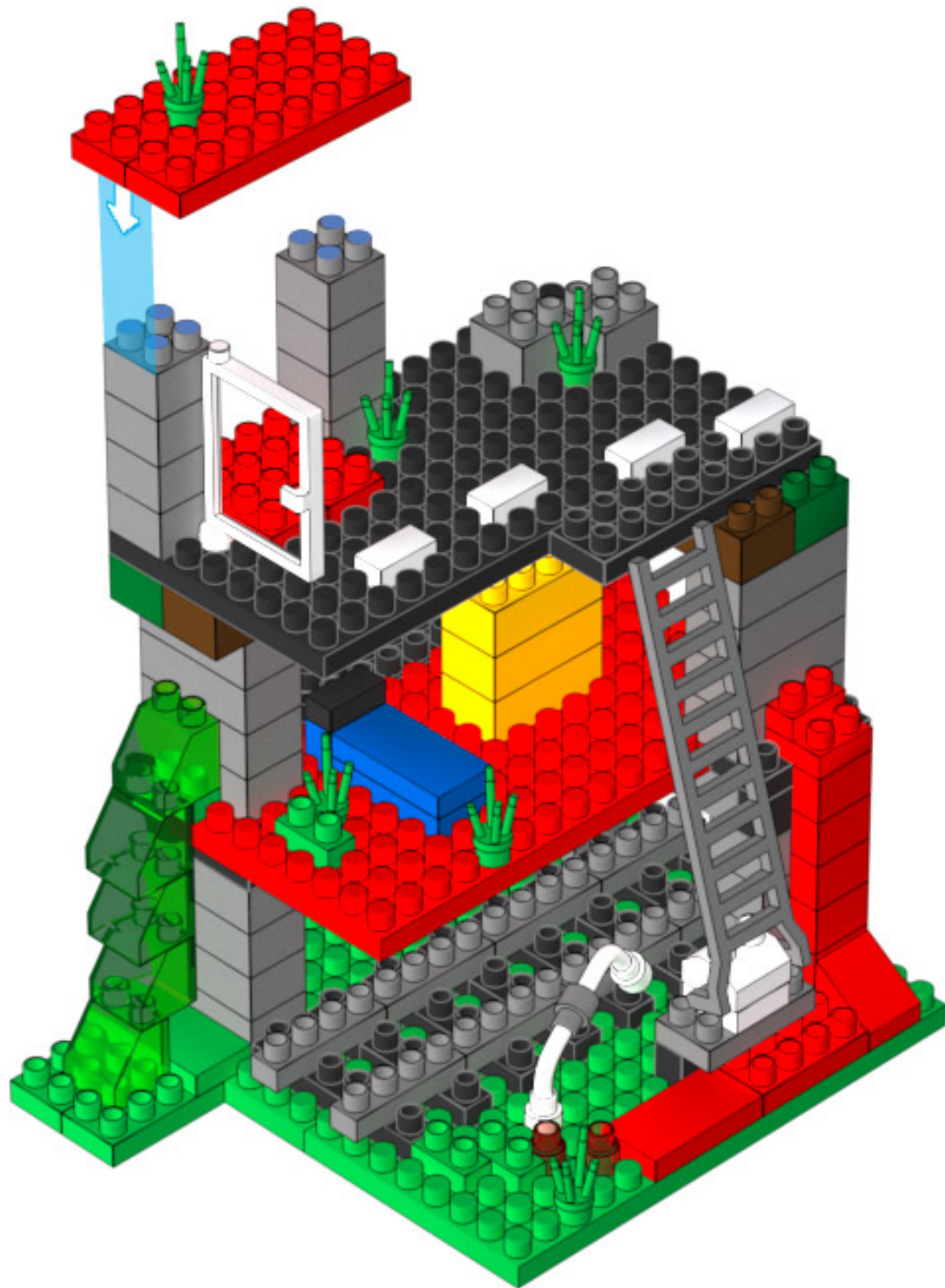

45

x2



46

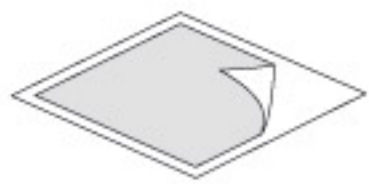

PEGADO DE STICKERS

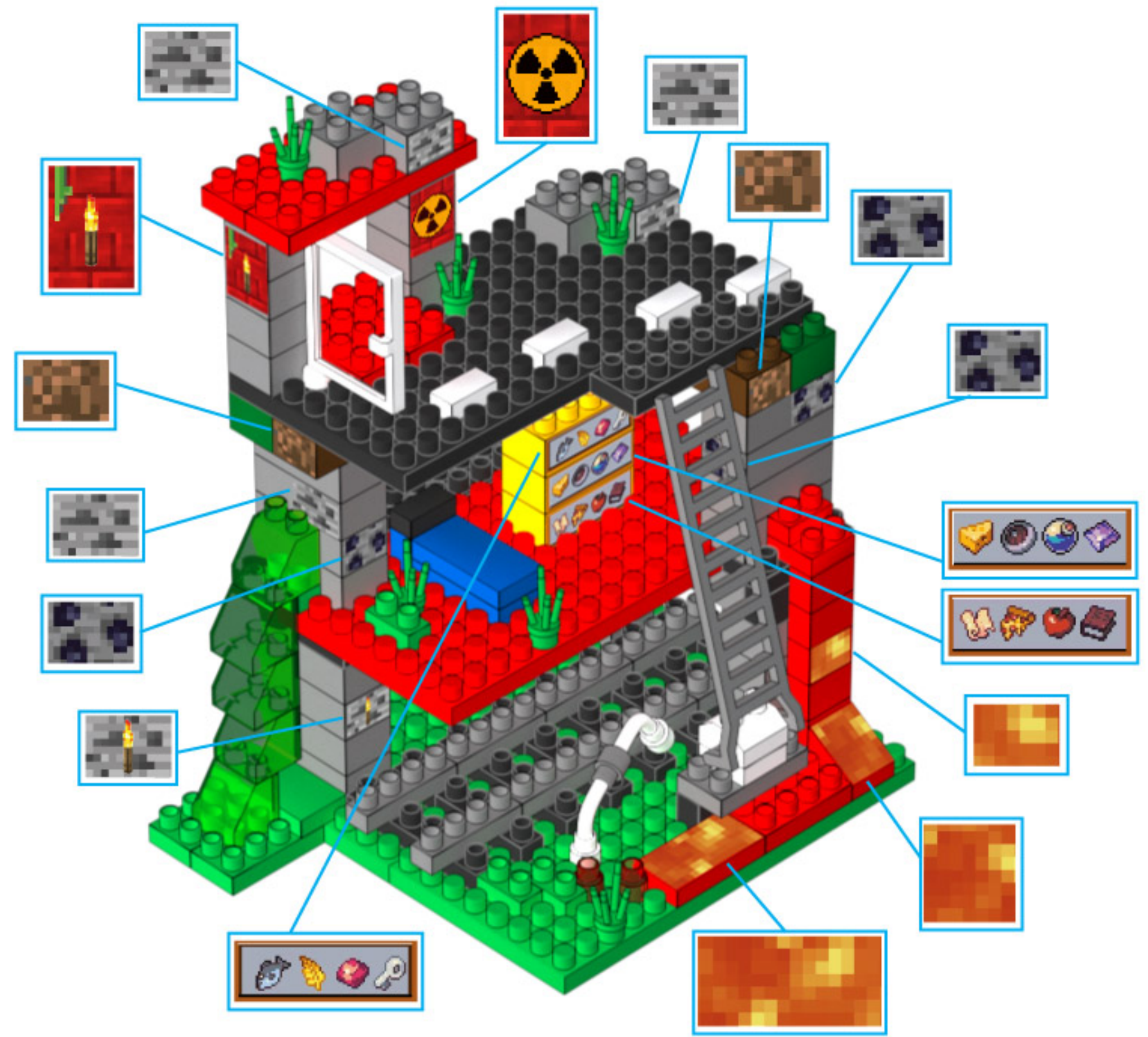

47

MODELO TERMINADO



BOMBAS

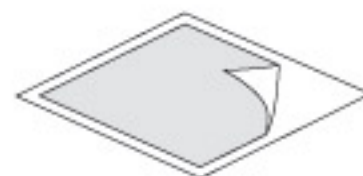
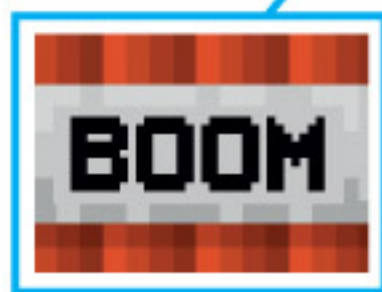
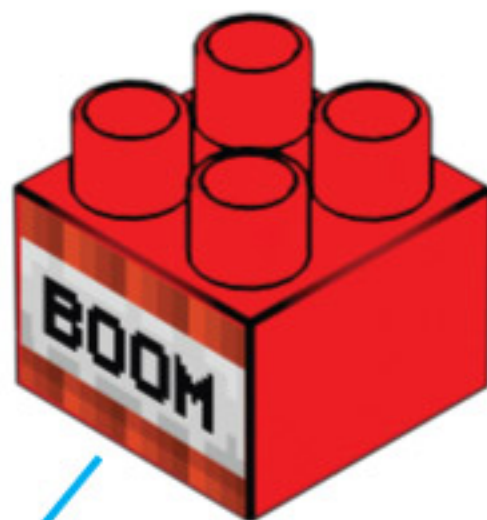
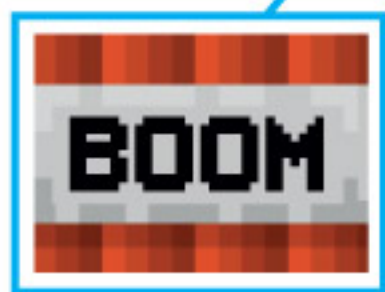
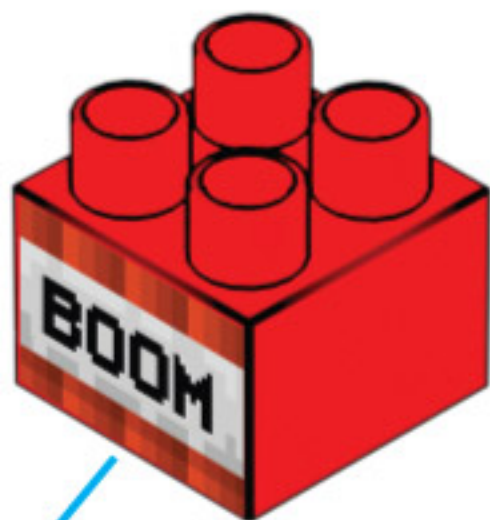

PEGADO DE
STICKERS

ARMADO DE RICK

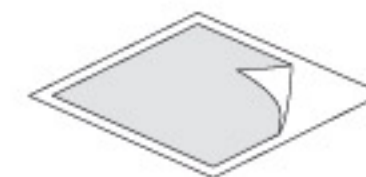
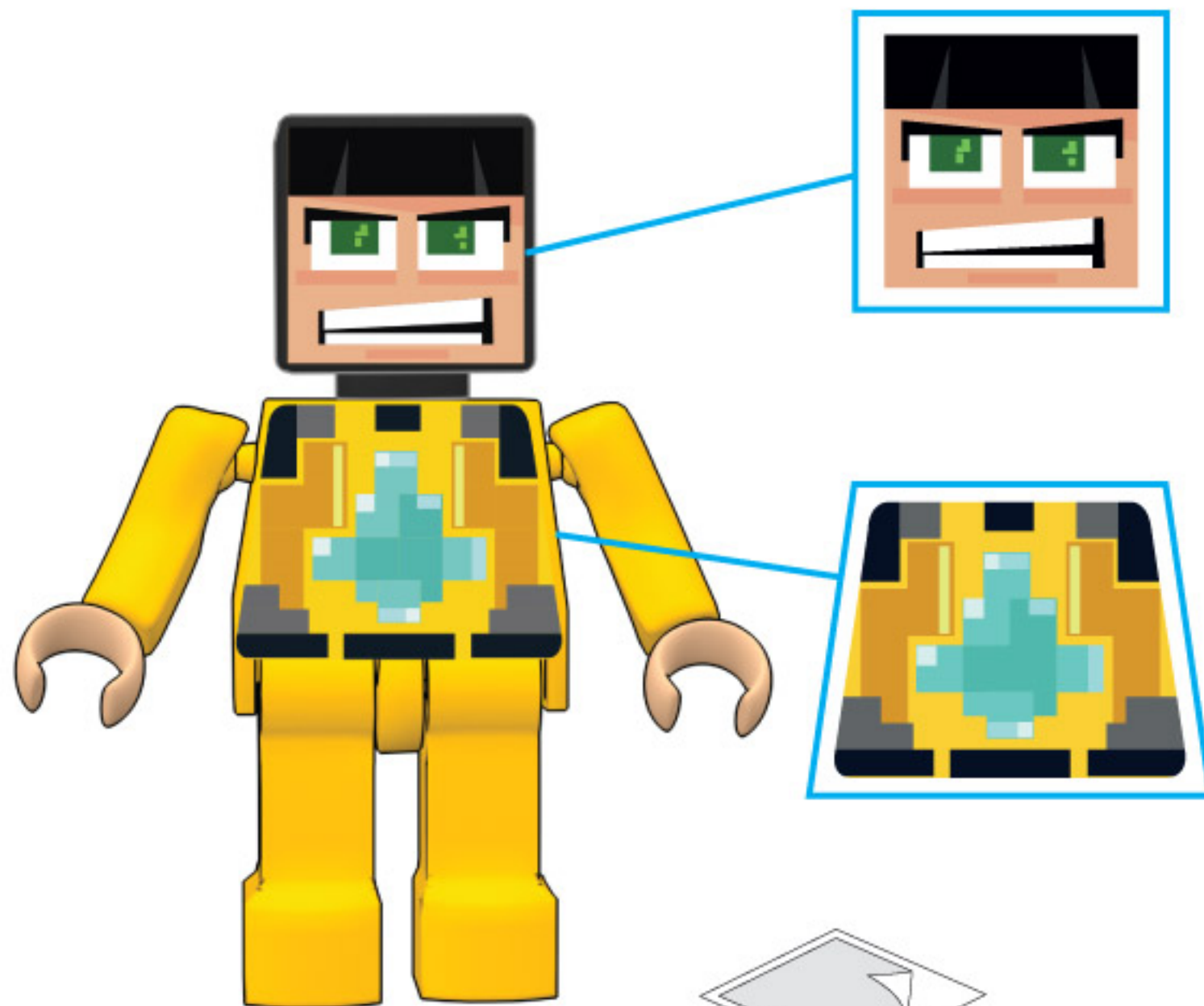
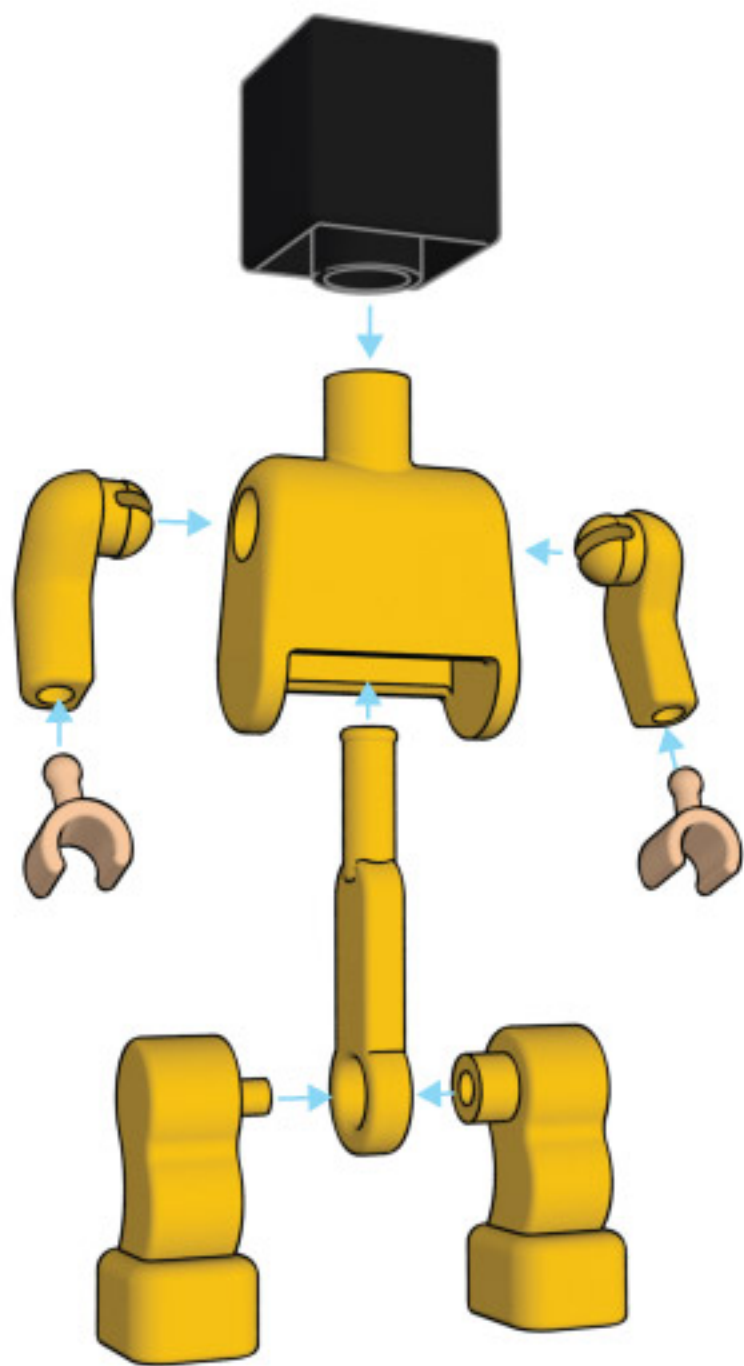

PEGADO DE
STICKERS

ARMADO DE JACK

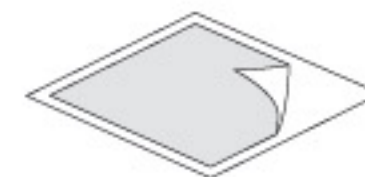
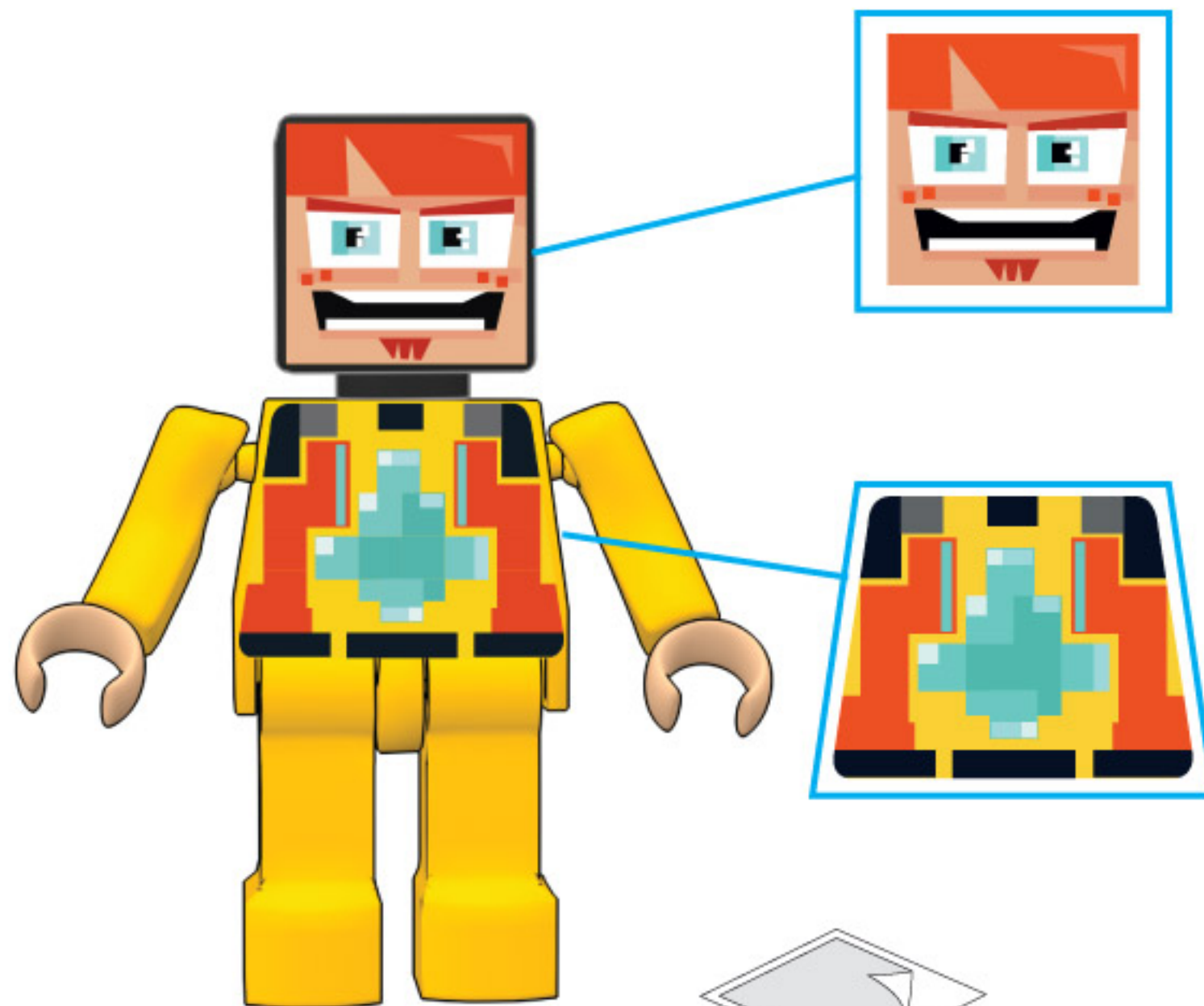
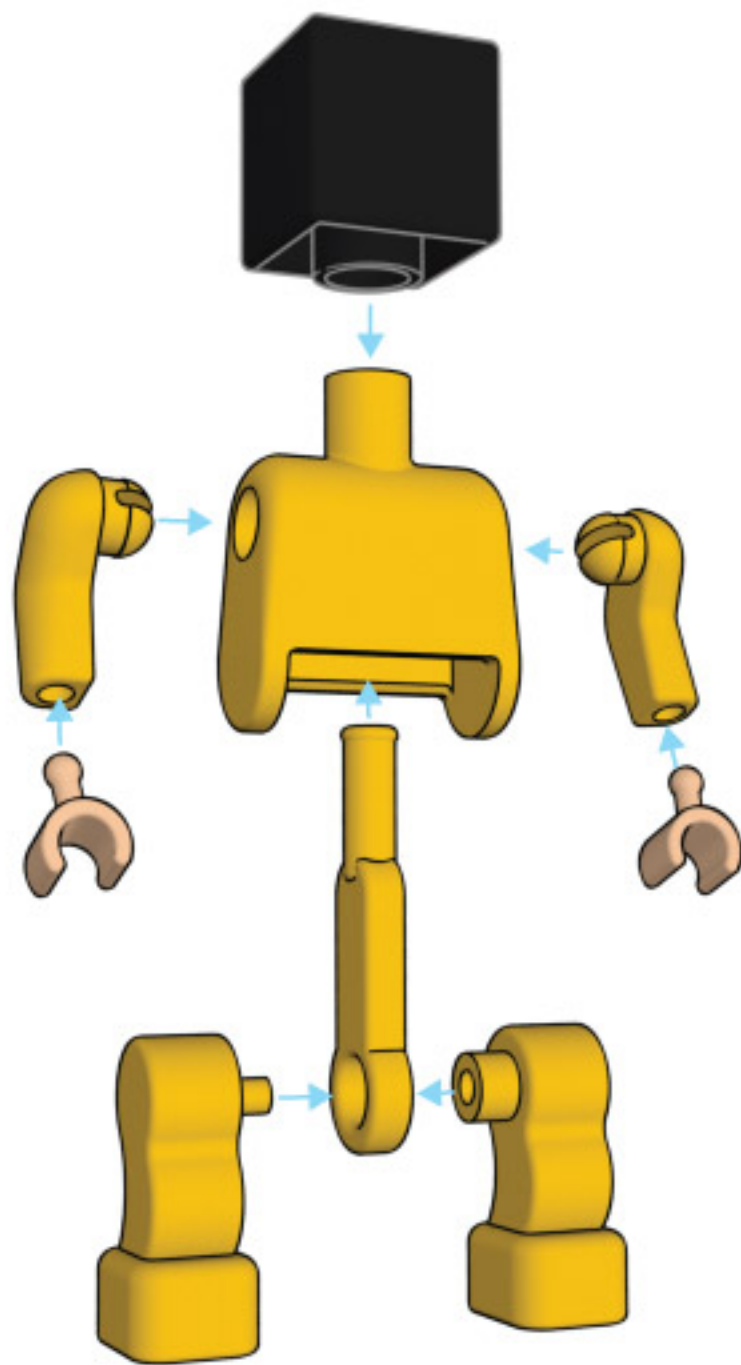

PEGADO DE
STICKERS

ARMADO DE ROMOR

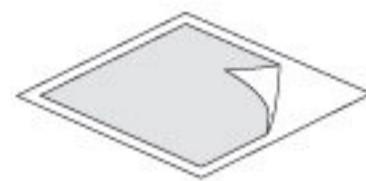
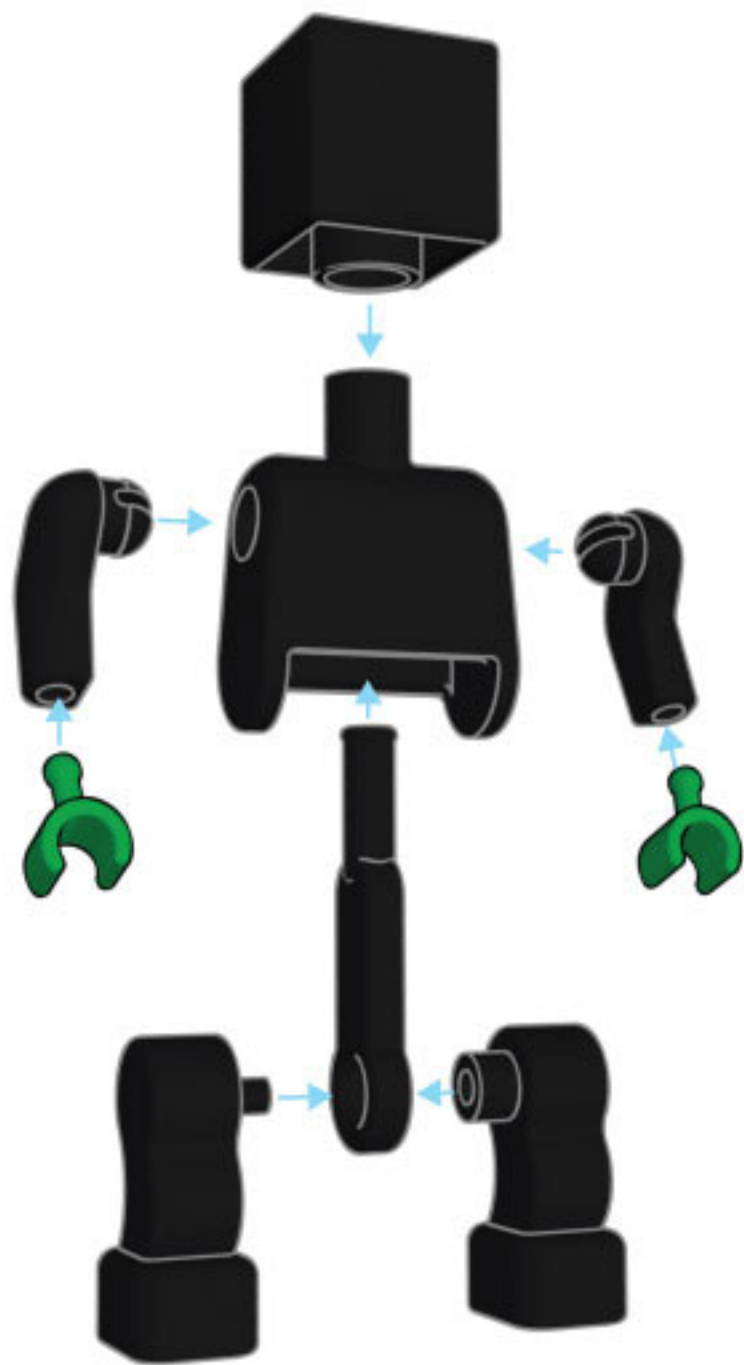

PEGADO DE
STICKERS